

# **VHF/FM AIRBORNE TRANSCEIVER MODELS TFM-138, 138A and 138B**

(does not include TFM-138, s/n 1540 and up,  
TFM-138B, s/n 1500 and up or TFM-138C)

## **Installation and Operating Instructions**

Til Document No.  
95RE177  
Rev. E

**JULY 2000**

**Technisonic Industries Limited**

240 Traders Blvd. E., Mississauga, Ontario L4Z 1W7 Tel:(905)890-2113 Fax:(905)890-5338

## **CAUTION**

This unit contains static sensitive devices. Wear a grounded wrist strap and/or conductive gloves when handling printed circuit boards.

## **WARRANTY INFORMATION**

The Model TFM-138 Series, VHF/FM Transceivers are under warranty for one year from date of purchase. Failed units caused by defective parts, or workmanship should be returned to:

Technisonic Industries Limited  
240 Traders Boulevard  
Mississauga,  
Ontario L4Z 1W7

Tel: (905) 890-2113 Fax: (905) 890-5338

## TABLE OF CONTENTS

<u>Paragraph</u>	<u>Title</u>	<u>Page</u>
<b>SECTION 1</b>		
<b>GENERAL DESCRIPTION</b>		
1.1	Introduction . . . . .	1-1
1.2	Description . . . . .	1-1
1.3	Purpose of Equipment . . . . .	1-1
1.4	Model Variation . . . . .	1-1
1.5	Technical Summary . . . . .	1-2
<b>SECTION 2</b>		
<b>OPERATING INSTRUCTIONS</b>		
2.1	Operating Features . . . . .	2-1
2.2	Operating Instructions . . . . .	2-1
2.3	Programming Instructions . . . . .	2-5
2.4	Scanning Function . . . . .	2-6
2.5	Priority and Selective Memory Channel Scanning . . . . .	2-6
2.6	Direct Frequency Entry Mode . . . . .	2-6
2.7	Receive Frequency Simplex Function . . . . .	2-7
2.8	Keyboard Lockout Function . . . . .	2-7
2.9	Variable Frequency Mode Function . . . . .	2-7
2.10	LED Display Variable Dimming Mode . . . . .	2-7
2.11	90 Second Transmitter Time Out Feature . . . . .	2-7
2.12	Quick Guard Programming Feature . . . . .	2-7
2.13	Programming CTCSS Tones . . . . .	2-8
2.14	PC Memory/Programming Download Capability . . . . .	2-9
<b>SECTION 3</b>		
<b>INSTALLATION INSTRUCTIONS</b>		
3.1	General . . . . .	3-1
3.2	Equipment Packing Log . . . . .	3-1
3.3	Transceiver Installation . . . . .	3-1
3.4	Installation Kit - Contents . . . . .	3-1
3.5	Wiring Instructions . . . . .	3-1
3.6	Installation - Pin Locations and Connections . . . . .	3-1
3.7	Wiring Instructions . . . . .	3-3
3.7.1	Main Power + 28VDC . . . . .	3-3
3.7.2	Main Ground . . . . .	3-3
3.7.3	PTT (Ground Keying) . . . . .	3-3
3.7.4	Front Panel Back Lighting . . . . .	3-5
3.7.5	Audio Outputs (600 and 4 Ohms) . . . . .	3-5
3.7.6	Audio Output Ground . . . . .	3-5
3.7.7	Mic Signal Input . . . . .	3-5
3.7.8	Memory Up/Memory Down . . . . .	3-5
3.7.9	Data Input . . . . .	3-5
3.8	Internal Enable/Disable Jumper . . . . .	3-5
3.9	Transmitter Power Adjustments . . . . .	3-7
3.10	Transmitter Microphone Level Adjustments . . . . .	3-7
3.11	Transmitter Sidetone Level Adjustments . . . . .	3-7
3.12	Main and Guard Squelch Adjustments . . . . .	3-9
3.13	Transmitter Deviation Adjustment . . . . .	3-9
3.14	Guard Receiver Audio Limit Feature . . . . .	3-9

Post Installation EMI Test . . . . .	A-1
--------------------------------------	-----

#### LIST OF TABLES

Table No.	Title	Page
3-1	1 5-Pin D Connections . . . . .	3-3

#### LIST OF ILLUSTRATIONS

Figure No.	Title	Page
2-1	Operator's Switches and Controls - TFM-1 38 . . . . .	2-2
2-2	Operator's Switches and Controls - TFM-1 38A and 138B . . . . .	2-3
2-3	TFM-1 38 Series Transceiver PC Download Cable - Wiring Diagram . . . . .	2-12
3-1	Outline Drawing for TFM-1 38 Series Transceiver . . . . .	3-2
3-2	Wiring Connections for TFM-1 38 Series Transceiver . . . . .	3-4
3-3	Internal Enable/Disable Jumper and TX High/Low Power Adjust Locations . . . . .	3-6
3-4	Microphone and Sidetone Level, Main and Guard Squelch Adjustment Access . . . . .	3-8
3-5	Deviation Adjustment Potentiometer Location . . . . .	3-10

# **IMPORTANT INFORMATION**

## **FOR INSTALLERS**

The Technisonic TFM-138 is supplied without TSO certification, as no such specification presently exists for airborne VHF/FIVI radio transceivers. This equipment provides what is considered a "supplemental" communications, and can be installed in an aircraft on a "non interference " basis. Installation should be performed using standard accepted procedures applicable to aircraft radio installation.

For Canadian installations , reference should be made to the basis of certification for the aircraft and other applicable requirements to determine whether the installation of this equipment is considered a minor modification and as such can be signed off by appropriate qualified and licensed personnel.

The TFIVI-1 38 is compliant with DO-1 60C, curve P, figure 8-4 for sinusoidal vibration test curves for equipment installed in helicopters, with category AI as per table 4-1 for temperature and altitude criteria, and with category A for the standard humidity and environmental category.

The use of red displays in the cockpit should be minimized or avoided so as not to detract from the attention getting characteristics needed in warning and caution annunciators. Red should be used to annunciate emergency conditions requiring immediate response by the flight crew. Units with red displays should not be located in close proximity to warning and caution annunciators. The installation of units with red displays must be evaluated on a case by case basis to ensure that the effectiveness of the warning and caution annunciators is not adversely affected.

## DO-160 Environmental Testing

Conditions	Section	Description of Conducted Tests
Temperature and Altitude	4.0 Rev. 1	Equipment tested to category A2
Vibration	8.0	Equipment tested without shock mounts to categories B, M and N
Magnetic Effect	15.0	Equipment is class Z
Power Input	16.0	Equipment tested to category B
Voltage Spike	17.0	Equipment tested to category
Radio Frequency Emissions	21.0	Equipment tested to category A

# **TFM-138B SOFTWARE CHANGE NOTE**

This document does not cover operation of the Technisonic TFM-138, s/n 1500 and onwards which have been delivered from the factory with version F14 software. For TFM-138B's with s/n 1500 or greater, TiL Document 97RE221 should be referred to.

This document does cover the operation of TFM-138B's with s/n 1499 or less.

## SECTION 1

# GENERAL DESCRIPTION

### 1.1 INTRODUCTION

This publication provides operating and installation information on the various TFM-138 Series, VHF/FM Transceivers manufactured by Technisonic Industries Limited. This include the Model TFM-138, 138A and 138B. These units offer an extended operating frequency range with selectable channel spacing (138B only) and is intended for use (in the US) only by government agencies or contractors thereto, who have obtained licensing for operation in the 138-150 MHz portion of the band. If these 138-Series transceivers are used in CANADA, operation is restricted to the following sub bands: 138-144, 148-148.99, 149.005-150.005 and 150.05-174 MHz.

### 1.2 DESCRIPTION

The TFM-138 Series, Transceivers are frequency agile, fully synthesized airborne transceivers capable of operating in the 138.000 MHz to 174.000 MHz frequency range in 2.5 KHz increments with either 25 KHz or 12.5 KHz channel spacing. The Transceiver can operate without restriction on any split frequency pair in the band and also incorporates a two channel synthesized guard receiver.

The TFM-138A and 138B Transceivers provides 120 (25 in the TFM-138) operator accessible memory positions, each of which is capable of storing a transmit frequency, receive frequency, transmit frequency CTCSS tone or DPL code (DPL n/a in TFM-138), receive frequency CTCSS tone or DPL code, an alphanumeric identifier for each channel and in the TFM-138B only, wideband (25 KHz) or narrowband (12.5 kHz) channel spacing assignment. Operating frequency and other related data are presented on a 48 character, two line LED matrix display. Data entry and function control are performed via a 12 button keypad. Preset channels may also be scrolled and scanned through keypad function activation. Data may also be entered via an MS-DOS based computer with the provided software and optional PC download cable, P/N 943165-1.

### 1.3 PURPOSE OF EQUIPMENT

The TFM-138 Series, VHF/FM Transceivers are designed to provide secondary airborne communications to facilitate operations which are typically performed in a low altitude environment. The transmitter section of this unit has a minimum of 8 watts and does not exceed 10 watts output power, which may be reduced by a front panel switch to 1 watt, in order to reduce interference to land based systems.

### 1.4 MODEL VARIATION

There are four variations of the Model TFM-138B Transceiver. All units offer identical features and performance except for the following differences:

TFM-138B, P/N 921012-1, Option B	GREEN display and 28 Volt back lighting.
TFM-138B, P/N 921012-1 (5V), Option B	GREEN display and 5 Volt back lighting.
TFM-138B, P/N 921012-2, Option B	RED display and 28 Volt back lighting.
TFM-138B, P/N 921012-2 (5V), Option B	RED display and 5 Volt back lighting.

Both P/N's 921012-1 and 921012-2 are always provided with 28 Volt back lighting unless a specific request is made for 5 Volt AC operation.



## 1.5 TECHNICAL CHARACTERISTICS

<u>Specification</u>	<u>Characteristic</u>
<u>GENERAL</u>	
Model Designation:	TFM-138, TFM-138A, TFM-138B
Frequency Range:	138.000 to 174.000 MHz
Tuning Increments:	2.5 KHz
Operating Mode:	F3E simplex or semi-duplex
Channel Spacing:	25 (or 12.5 KHz in 138B)
Physical Dimensions (including heatsink):	Approx. 8.0" X 3.0" X 5.75"
Weight:	Approx. 3.1 Lbs (1.4 Kg)
Mounting:	Panel Mount via Dzus fasteners
Operating Temperature Range:	-40EC to + 60EC
Power Requirement:	
Voltage:	28.0 Vdc, $\pm$ 15%
Current:	Receive - 0.7 A Max. 1 Watt Transmit - 1.3 A Max. 8-10 Watt Transmit - 2.0 A Max.
Frequency Selection: (25 memories and no DPL in TFM-138)	120 memories programmed with: a) Tx Frequency/Rx Frequency b) Tx/Rx CTCSS tone or DPL code c) 9 character alpha numeric title
Guard Receiver:	2 channels programmed with: a) Tx Frequency/Rx Frequency b) Tx CTCSS tone or DPL code c) 9 character alpha numeric title
CTCSS squelch/encoder:	All CTCSS tones available
DPL digital squelch/encoder:	All standard DPL codes (Not available in TFM-138)
DTMF encoder:	All standard DTMF tones
Audio Output:	0.5 Watts into 600 ohms
Speaker Output:	2.5 Watts min. into 4 ohms
Back Lighting:	28 Volts (standard) or 5 Volts (specify)
Display Colour:	Green (standard) or Red (specify)

DPL is a trademark of Motorola Corporation

## 1.5 TECHNICAL CHARACTERISTICS (continued)

### MAIN RECEIVER

Sensitivity at 12 dB SINAD	Better than 0.35 $\mu$ V
Adjacent Channel Selectivity	-70 dB (25 or 12.5 KHz)
Spurious Attenuation	-90 dB
Third Order Intermodulation	-70 dB
Image Attenuation	-80 dB
FM Acceptance	$\pm$ 6 KHz
Hum and Noise	Better than 50 dB
Audio Distortion	less than 5%
Antenna Conducted Emission	less than -70 dBm

### GUARD RECEIVER

All specifications identical to main receiver

### TRANSMITTER

RF Power Output	1 watt or 10 watts
Output Impedance	50 ohms
Maximum Deviation (In TFM-138B, narrowband)	$\pm$ 5 KHz (25 KHz mode) $\pm$ 2.5 KHz(12.5KHz mode)
Spurious Attenuation	-90 dB below carrier level
Frequency Stability	$\pm$ 0.0005%
Microphone Circuit	Carbon or equivalent
Sidetone Output	0.5W (max) into 600S
Harmonic Attenuation	-65 dB below carrier level
FM Hum And Noise	-40 dB
Audio Input	50 mV at 2.5 KHz into 200 S input circuit for $\pm$ 3.5KHz deviation, adjst.
Audio Distortion	Less than 5%

## SECTION 2

### OPERATING INSTRUCTIONS

#### 2.1 OPERATING FEATURES

The equipment has several important operating features which provide maximum flexibility, performance and versatility. These features include:

1. 120 memory positions which can each be programmed with a transmit and receive frequency with 25 or 12.5 KHz channel spacing, Tx/Rx CTCSS tones or DPL codes and a 9-character alphanumeric title. (25 memory positions and no DPL in TFM-138).
2. 2 guard channels which can each be programmed with a Rx frequency with 25 or 12.5 KHz channel spacing, CTCSS Tx tone or DPL code and a 9-character alphanumeric title.
3. Scanning of preprogrammed memories with selective memory scanning.
4. Priority scan of memory channel 1, if desired.
5. Direct frequency entry mode.
6. Receive frequency simplex function.
7. Switchable RF output power between 1 watt and 8-10 watts.
8. Lockout of keyboard to prevent inadvertent entries.
9. Variable frequency mode to manually scan up and down in 2.5 kHz steps.
10. LED display variable dimming mode.
11. Selectable 90 second Tx time out feature.
12. Quick download of any of the 120 memory positions to the guard memories. (Only in 138A and 138B).
13. PC Memory download capability.

#### 2.2 OPERATING INSTRUCTIONS (See Figure 2-1)

1. Switch power on by turning the main volume clockwise. The last programmed frequencies will be displayed. The transceiver is now in normal operating mode.
2. Adjust the audio level by adjusting the main and guard volume knobs.
3. Pressing the squelch defeat button will open both receivers to confirm they work.

**For TFM -138 see following paragraphs 4 and 5 with Figure 2-1.**

4. Read the display. The top line will indicate which memory position is selected, alphanumeric message and frequency of the main receiver. The bottom line indicated similar information about the guard receiver. At the beginning of each line, an LED indicates open squelch.

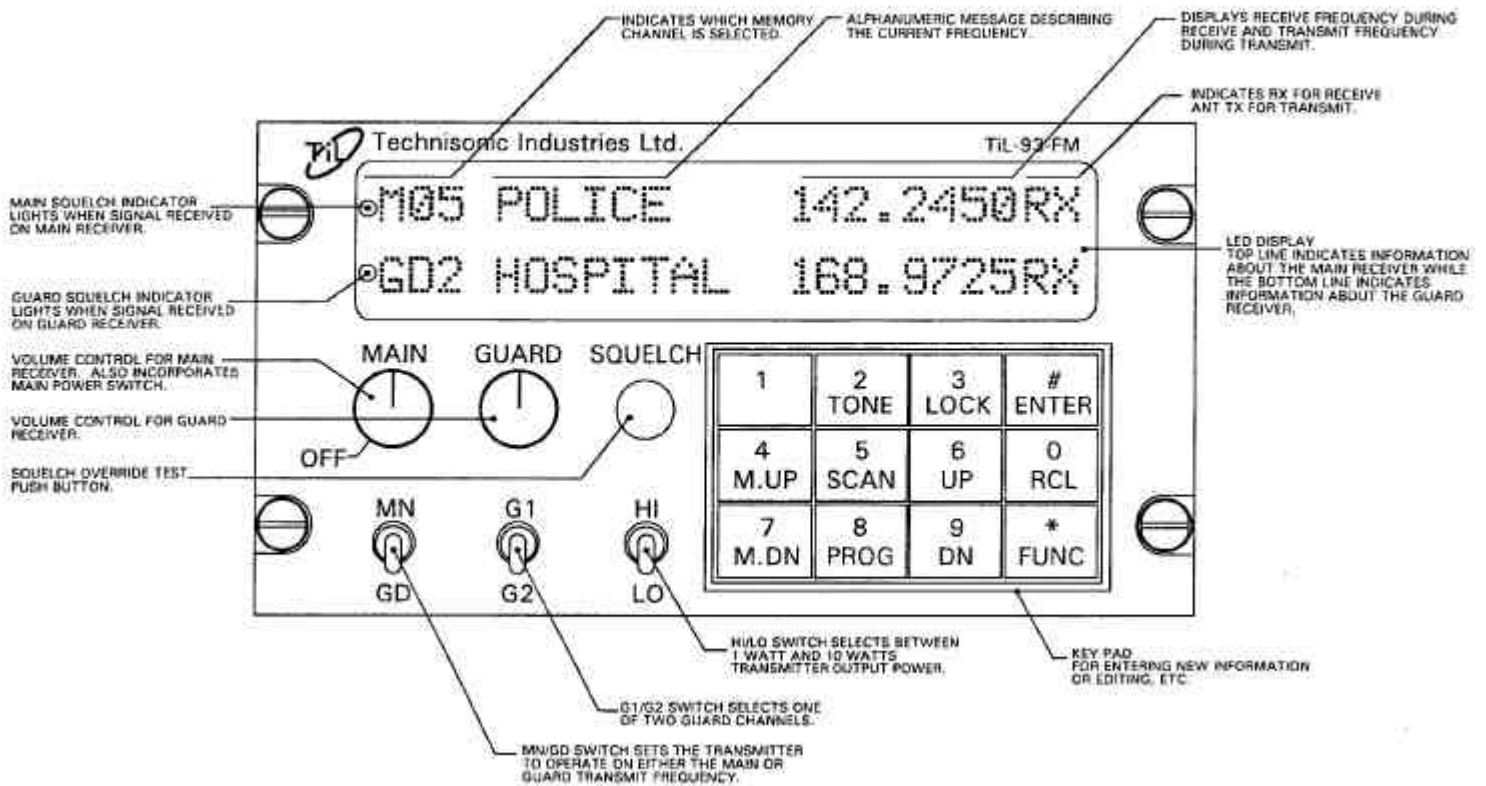

FIGURE 2-1 Operator's Switches and Controls - TFM-138

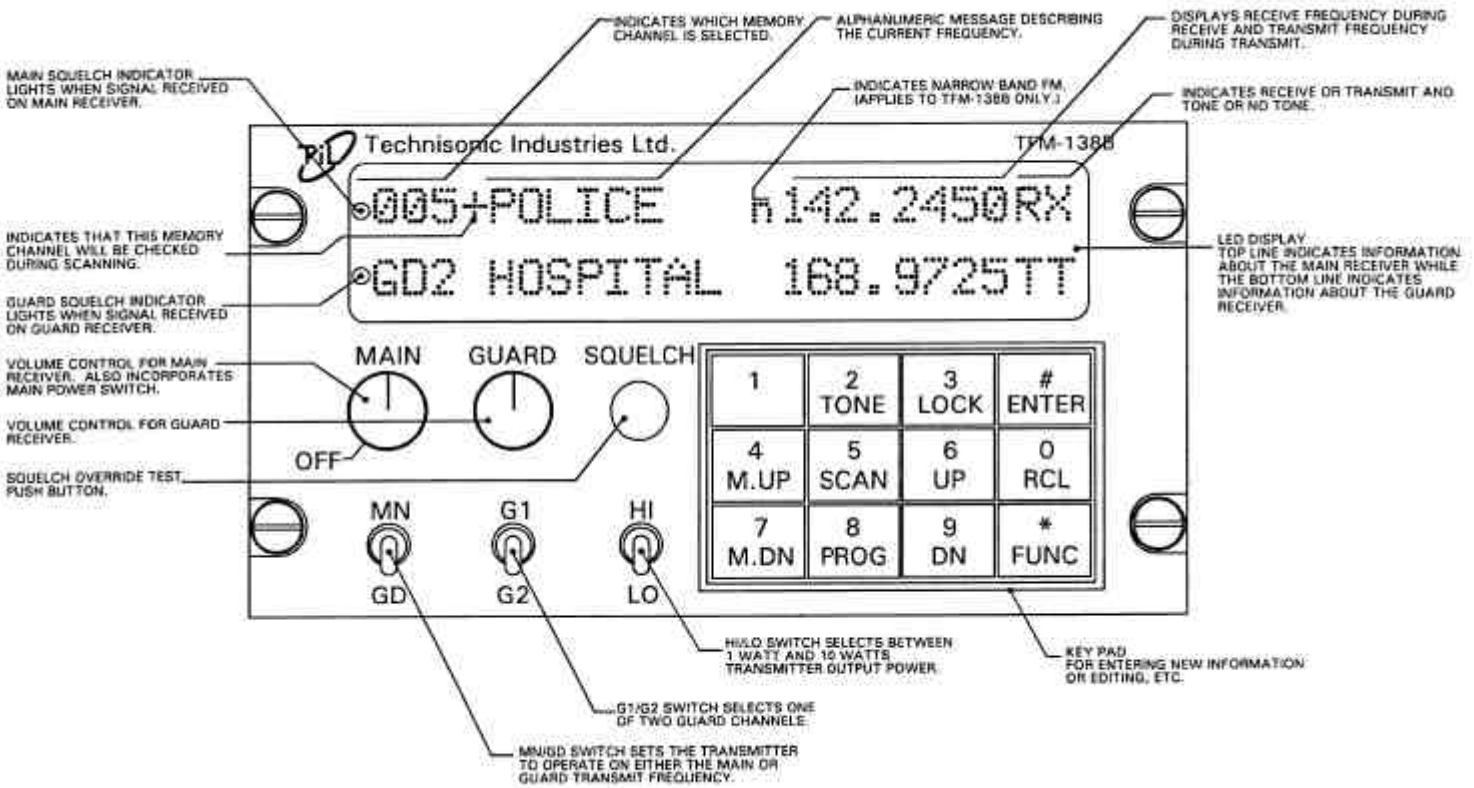

FIGURE 2-2 Operator's Switches and Controls - TFM-138A and 138B

## 2.2 OPERATING INSTRUCTIONS - continued

5. Only TX CTCSS tones may be programmed for the guard receiver. At the beginning of each line, an LED indicates open squelch.

**For TFM -138A and TFM-138B see following paragraphs 4A and 5A with Figure 2-2.**

- 4A. Read the display. The top line will indicate which memory is selected followed by a "+" if the memory position is included in the scan list, an alphanumeric message, and the frequency of the main receiver. A small "n" before the frequency indicates 12.5 kHz narrowband channel spacing is in effect on this memory position. In the receive mode, the frequency is followed by an "RT" if a RX CTCSS tone or RX DPL code is programmed, or an "RX" if no Receive tone/code is programmed. Similarly, in the transmit mode either a "TT" or "TX" is shown after the frequency. The bottom line indicates similar information about the guard receiver.
- 4B. Only TX CTCSS tones or TX DPL codes may be programmed for the guard receiver. At the beginning of each line, an LED indicates open squelch.
6. Set the MN/GD switch to main or guard transmit frequency.
7. Set the G1/G2 switch to the desired guard channel.
8. Set the HI/LO switch to the desired RF output power.
9. Select the desired memory by using the M.UP and M.DN buttons, or the RCL button and a three digit number followed by ENTER.
10. To transmit DTMF tones, use the keyboard keys while holding the PTT button on the microphone. The keyboard returns to its normal function when the PTT is released.

The display always shows the status of both receivers and the transmitter. The light at the left of the top and bottom line indicates which receiver is receiving. The display also indicates the memory channel in use and the guard channel in use. A "TX" on the right side of the display indicates whether the guard or main channel is active when transmitting. The transmit frequency is also shown.

### **For the TFM-138A and TFM-138B**

(A "TX" (no TX tone/codes programmed) or "TT"(either TX tone or code programmed) on the right side of the display indicates whether the guard or main channel is active when transmitting. The transmit frequency is also shown. In the receive mode the display shows "RX" beside the receive frequency if no RX tone or DPL code is programmed and "RT" if a CTCSS tone or DPL code is programmed.)

When the transceiver is in either of the operating frequency or CTCSS tone/DPL code programming modes and you must respond to a call, click the microphone PTT once (the radio will not transmit during this click). This will cause the transceiver to revert back to the normal operating mode and communications with the caller can proceed in the usual fashion.

## 2.3 PROGRAMMING INSTRUCTIONS

To program one of the 120 memory channels in the TFM-138A or 138 B, or one of the 25 memory channels in the TFM-138:

1. Press the **FUNC** key. The display will show the function prompt.
2. Press the **PROG** key. The display will show the current receive frequency with a flashing cursor on the second digit (The first digit is always a one < 1 >).
3. Type in the desired receive frequency. If you type in a frequency which is not a 2.5 kHz step, the nearest valid frequency will be automatically selected.
4. The cursor will return to the second digit. You can now retype the frequency if you made an error or press **ENTER** to continue.
5. The transmit frequency will be displayed with the cursor on the second digit. Follow the same method as in step 3 and 4.
6. **This step applicable to the TFM-138B only.** The channel spacing increment of either 25.0 or 12.5 KHz is now displayed. Use the **M.UP** and **M.DN** keys to select the desired channel spacing for the memory position, then press **ENTER**.
7. The alpha-numeric title is now displayed. Use the **M.UP** and **M.DN** keys to scroll through the alphabet, numbers and symbols. When the desired character is displayed, press **ENTER** to advance to the next character.
8. Keep repeating step six until the last space is set. The display will show SCAN or LOCKOUT to enable this memory position as part of the scan list or lock it out of the scan list. Use the **M.UP** and **M.DN** keys to toggle between these functions (for details see paragraph 2.5). Once the desired condition has been selected, press **ENTER**. On the TFM-138A or TFM-138B the display will show a " + " beside the memory channel number if scan is enabled.
9. The display will now show the current memory number. Type in the 2-digit (TFM-138) or 3-digit (TFM-138A or 138B) number of the memory you want to save to (if different from displayed one) and press **ENTER**.
10. You now have the option to program the guard frequencies by pressing **FUNC** or press **ENTER** to return to normal operating mode.
11. If you pressed **FUNC** to program the guards, guard"1" transmit frequency will be displayed with the flashing cursor on the second digit. Enter the frequencies for guard"1" receive/transmit and guard"2" receive/transmit as in step 3 and 4.
12. The alphanumeric labels for guard"1" and guard"2" are entered the same as in step 7 and 8. When the last character is entered, the radio returns to normal operating mode. **NOTE: (For the TFM-138B only),** If the guard is to be programmed for 12.5 KHz narrowband operation, use the QUICK GUARD PROGRAMMING FEATURE described in paragraph 2.12. A memory position must be programmed to the 12.5 KHz mode then the contents can be quickly downloaded to GD1 or GD2 memory positions.

Programming of memory is disabled when the internal entry disable jumper is set. Alternatively any transceiver can be programmed by an IBM PC or compatible computer. See section 2.14

**PC Memory/Programming Download Capability.**

## 2.4 SCANNING FUNCTION (5 second talkback delay)

1. To start scanning of the memory channels, press **FUNC** then **SCAN**.

The radio will scan through all the preset memory positions (see next paragraph for priority and selective scan features) and will lock on to the first active channel in the scan sequence. It will remain on the channel until it becomes inactive. Scanning will resume again after five seconds of inactivity. To exit the scan mode, press the **SCAN** key. This will cause the radio to revert back to the normal operating mode.

Therefore if while scanning, you hear a call for you:

1. Respond to the call within 5 seconds. When scanning is interrupted by an incoming signal, the channel will remain open for five seconds before resuming scanning.
2. During communications the five second timer is reset from the last Rx or Tx signal experienced.

The radio resumes scanning once the Rx or Tx activity has ceased for more than five seconds. The **SCAN** key must be pressed to exit the scan mode.

## 2.5 PRIORITY AND SELECTIVE MEMORY CHANNEL SCANNING

The priority memory channel is always memory position number 1. The priority memory channel is scanned every other step (ie. 121314151...) to ensure that no incoming messages are missed. The priority channel can be locked out, which will result in the normal scanning of the other memory positions.

Selective memory scanning allows the user to select which of the 25 (in the TFM-138) or 120 (In the TFM-138A or 138B) memory channels are to be scanned or locked out when the scan function is invoked. To use this feature, follow the PROGRAMMING INSTRUCTIONS found in paragraph 2.3. Once the screen displays **SCAN** or **LOCKOUT**, use the **M.UP** or **M.DN** keys to toggle to the desired condition and press **ENTER**. In normal operating mode the display (of the TFM-138A or 138B only) will later show a "+" beside the memory channel number if scan is enabled.

## 2.6 DIRECT FREQUENCY ENTRY MODE

This mode is designed to facilitate quick frequency selection during emergency and other operational conditions requiring direct operating frequency selection. This operating mode is disabled along with the programming mode when the internal disable jumper is set.

1. When the transceiver is in the normal operating mode, press **FUNC** and the desired operating frequency ie/ 153.275.

Please note in the above operation, after **FUNC** and "1" are entered, the LED display will show memory channel "000" ("00" in the TFM-138) and then the remaining digits in the desired frequency are shown as they are entered. No alphanumeric message can be entered in this mode. Operation on the new frequency occurs in both transmit and receive (simplex only) modes. If RX or TX CTCSS tones/DPL codes are required they must be programmed on.



## 2.7 RECEIVE FREQUENCY SIMPLEX FUNCTION

The receive frequency simplex function allows you to quickly change the transmit frequency, when operating on a split pair (repeater/semi-duplex mode), to the receive frequency to allow direct communications. ie/ If you are transmitting on 152.000 MHz and receiving 152.555 MHz, press **FUNC** then **UP** to transmit on 152.555 MHz. To return to the split pair condition, you must recall the memory channel again. This is quickly done by pressing **M.UP** for one step up, then back down one step with the **M.DN** key.

## 2.8 KEYBOARD LOCKOUT FUNCTION

The keyboard can be locked out so that accidental pressing of keys does not change frequency, etc., unknowingly to the operator. To lock the keyboard, press **FUNC** then **LOCK**. This will disable all keyboard functions (except keyboard unlock) in the receive mode. The DTMF function during transmit will not be affected. To unlock the keyboard, press and hold the **LOCK** key for two seconds until the display indicates "UNLOCK".

## 2.9 VARIABLE FREQUENCY MODE FUNCTION

To enter variable frequency mode, press **RCL, 0,0,0**, (**RCL, 0,0** in the TFM-138) then **ENTER**. The memory channel that you were just in will still be valid but now you can manually adjust the frequency with the **M.UP**, **M.DN**, **UP** and **DN** keys. The **UP** and **DN** keys will make the frequency count up or down in steps of 2.5 kHz. The **M.UP** and **M.DN** keys will make the frequency count up or down in steps of 1 MHz. You can not change the label. The frequency in this mode can not be stored in memory. To exit this mode, recall one of the 25 (in the TFM-138) memory channels (ie. **RCL,0,1**) or 120 (in the TFM-138A and 138B) memory channels (ie. **RCL, 0,0,1**). Variable frequency mode is disabled when the internal entry disable jumper is set.

## 2.10 LED DISPLAY VARIABLE DIMMING MODE

1. With the transceiver in normal operating mode press the **UP** or **DN** keys to increase or decrease the intensity of the LED display.
2. Once maximum intensity of the display is achieved, the **UP** key no longer functions. Conversely once minimum intensity is reached, the **DN** key ceases to function.

## 2.11 90 SECOND TRANSMITTER TIME OUT FEATURE

A selectable 90 second transmitter time out feature is provided to prevent accidental continuous transmission in the event of a faulty PTT switch. With this feature enabled the transceiver will stop transmitting after the PTT is engaged continuously for 90 seconds. The timer is reset by releasing then re-engaging the PTT switch.

Press the **FUNC** then the **M.UP** key. Use the **M.UP** and **M.DN** keys to select 90 SEC, which enables the feature, or NONE which disables it.

## 2.12 QUICK GUARD PROGRAMMING FEATURE (Available in TFM-138A or 138B only)

A quick download of any of the 120 memory positions to either of the guard memory positions can be accomplished. Select the memory position whose contents you desire to download to a guard memory. Select either GD1 or GD2 memory channel as desired. Press **FUNC** then **7**. The guard memory channel will now contain all the same information as the selected memory position.

## 2.13 PROGRAMMING CTCSS TONES/DPL CODES

**NOTE:** The TFM-138 supports only CTCSS tone functions. The TFM-138A and 138B support both CTCSS tone and DPL code functions.

CTCSS tones (PL tones) or Digital DPL codes can be assigned to each memory channel. The guard receiver squelch will operate only on carrier detection, but guard 1 and 2 transmit tones or codes can be programmed. To program a tone/code to a memory channel:

1. Use the **M.UP** and **M.DN** keys to select the memory channel that you want to assign a CTCSS tone or DPL code.
2. Press the **FUNC** key then the **TONE** key. The display will show "RX TONE:" and the current tone number, as well as the tone frequency in Hz.
3. Use the **M.UP** and **M.DN** keys to select the tone number you require. The following is a list of the available CTCSS tones:

<u>Number</u>	<u>Tone</u>	<u>Number</u>	<u>Tone</u>	<u>Number</u>	<u>Tone</u>
01	67.0	26	162.2	51	177.3*
02	71.9	27	167.9	52	183.5*
03	74.4	28	173.8	53	189.9*
04	77.0	29	179.9	54	196.6*
05	79.7	30	186.2	55	199.5*
06	82.5	31	192.8	56	206.5*
07	85.4	32	203.5	57	210.7*
08	88.5	33	33.0*	58	218.1*
09	91.5	34	35.4*	59	225.7*
10	94.8	35	36.6*	60	229.1*
11	97.4	36	37.9*	61	233.6*
12	100.0	37	39.6*	62	241.8*
13	103.5	38	44.4*	63	250.3*
14	107.2	39	47.5*	64	No Tone
15	110.9	40	49.2*		(carrier squelch only)
16	114.8	41	51.2*		(The tones marked with * are nonstandard tones).
17	118.8	42	53.0*		
18	123.0	43	54.9*		
19	127.3	44	56.8*		
20	131.8	45	58.8*		
21	136.5	46	63.0*		
22	141.3	47	69.4*		
23	146.2	48	159.8*		
24	151.4	49	165.5*		
25	156.7	50	171.3*		

4. Press ENTER. "TX TONE" appears on the display. Repeat step 3.
5. Press ENTER. "G1 TONE" appears on the display. Repeat step 3.

## 2.13 PROGRAMMING CTCSS TONES/DPL CODES - continued

6. Press ENTER. "G2 TONE" appears on the display. Repeat step 3 and press ENTER.

**CTCSS tone programming of the TFM-138 is now complete. The following paragraphs apply to the TFM-138A and TFM-138B only.**

7. The display will now show "RX DPL:" and the current 3-digit DPL code. If no DPL code is required "000" should be entered. Please note that if a DPL code is to be programmed a CTCSS tone should not be enabled.
8. Use the keypad to enter the required octal 3-digit DPL (Digital Coded Squelch or DCS) code. A list of all usable and unique octal 3-digit DPL/DCS codes follows:

017*	051	116	156	243	266*	346	431	466	612	721
023	053*	122*	162	244	271	351	432	503	624	731
025	054	125	165	245	274*	356*	445	506	627	732
026	065	131	172	246*	306	364	446*	516	631	734
031	071	132	174	251	311	365	452*	523*	632	743
032	072	134	205	252*	315	371	454*	526*	654	754
036*	073	143	212*	255*	325*	411	455*	532	662	
043	074	145*	223	261	331	412	462*	546	664	
047	114	152	225*	263	332*	413	464	565	703	
050*	115	155	226	265	343	423	465	606	712	

\* indicates GE Digital Coded Squelch (DCS) Code

9. Press ENTER. "TX DPL" appears on the display. Repeat step 8.
10. Press ENTER. "G1 DPL" appears on the display. Repeat step 8.
11. Press ENTER. "G2 DPL" appears on the display. Repeat step 8 and press ENTER.

## 2.14 PC MEMORY/PROGRAMMING DOWNLOAD CAPABILITY

The TFM-138 Series transceivers can be programmed by a MS-DOS based personal computer. This is an alternative to programming data manually by the keypad. A 3.5" disk containing the required PC download software is provided with each TFM-138 Series transceiver.

### Requirements:

1. PC compatible computer with any monitor, 3.5" floppy drive and a printer port (LPT1).
2. Bench power supply of 12 to 30 volts DC. The TFM-138B requires 28 volts to operate fully (transmit) but can be programmed at voltages as low as 12 volts.
3. PC download cable, P/N 943165-1 which can be supplied or made from the wiring diagram at the back of this section.

## 2.14 PC MEMORY/PROGRAMMING DOWNLOAD CAPABILITY - continued

### Installation:

1. Insert the floppy disk into drive A and type: A:INSTALL < enter >
2. All the files will be copied to your hard drive into a directory called \PCDL for TFM-138 or \PCDLA for TFM-138A or \PCDLB for TFM-138B.

### Connections:

1. With the PC turned off, plug the 25 pin male 'D' connector into its printer port.
2. Plug the 15 pin 'D' connector into the back of the TFM-138 Series transceiver.
3. Connect the power wires to the power supply.

### Running the program:

1. Turn on the power supply and the TFM-138 Series unit first and then turn on the PC.
2. Change to the \PCDL (\PCDLA or \PCDLB as applicable) directory and type: PCDL (PCDLA or PCDLB as applicable) and < enter > . The main menu will be displayed.

### Listing memory channels:

The first channel listed (in blue on colour monitors) is the memory channel that will appear on the display of the TFM-138 Series unit when it is turned on. The next two channels listed are guard 1 and guard 2. (in red on colour monitors) Only TX CTCSS tones or TX DPL codes are listed for the guards since the TFM-138 Series units have a CTCSS tone/DPL code decoder for the main receiver only. The rest of the memory channels displayed (in yellow) are the 120 (or 25 in the TFM-138) memories listed in sequence. Either LOCK or SCAN is displayed for each memory channel which indicates whether that memory channel will be included in the scan list or locked out. After reviewing the multi- page list, you have the option to return to the final page, for further review, to return to the main menu or to print out the memory channel list.

### Edit menu:

You can select which memory channel to program, main or guard. When entering memory channel information, if you just press return, the previous information will be retained. For example, you only want to change the receive frequency. Type in the new receive frequency and press return for all of the other prompts. You also will not be able to type in frequencies or information that does not make sense. If the information entered is not what was prompted for, you will be re-prompted for the correct information. For example, if you type in 999.9999 for the transmit frequency you will be prompted again because the frequency range of the TFM-138 Series product is 138 to 174 MHz. Keep in mind that the label for the memory channel can only have characters that exist on the TFM-138 Series units. These include only capital letters, numbers 0 to 9 and a few other characters. Any other character will show up as a blank on the unit's display.

You will then be prompted to enter a receive CTCSS tone, a transmit CTCSS tone, a receive DPL code and a transmit DPL code. Although both CTCSS tones and DPL codes can be programmed simultaneously, this should not be done. Care should also be taken to program the correct DPL code since non-unique (inverted) code numbers will be accepted.

**Downloading to the Transceiver:**

Select 'D' from the main menu. Follow on screen instructions. The memory channels will be downloaded sequentially to the TFM-138 Series unit. You will be able to see them on the radio's display as they go by. The download process will take several minutes. (The data transfer is fast but the nonvolatile memory in the radio needs time to program.) The PC will return to the main menu when the process is complete. The radio will also return to the normal operating mode when done.

**Files:**

The file containing the memory channel list is named 'DATA1' in the \PCDL (\PCDLA or \PCDLB as applicable) directory. The program will not run if it can not find the 'DATA1' file. To have multiple databases, you can copy the data file to a new name and edit the 'DATA1' file again. To retrieve a database, copy it back to 'DATA1'.

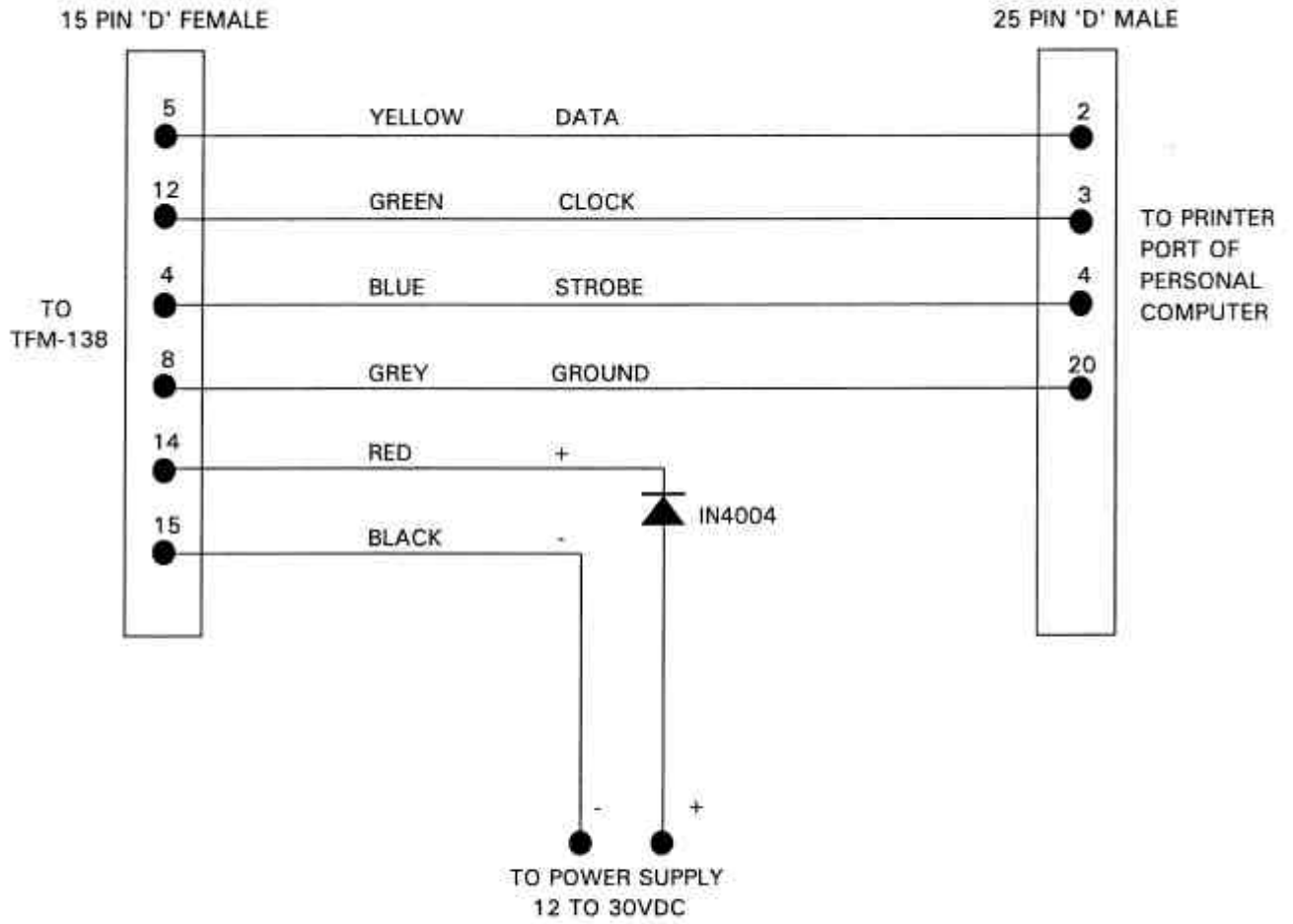

944032A

FIGURE 2-2 TFM-138B Transceiver PC Download Cable - wiring diagram

## SECTION 3

### INSTALLATION INSTRUCTIONS

#### 3.1 GENERAL

This section contains information and instructions for the correct installation of the TFM-138, 138A or 138B, VHF/FM Transceivers.

#### 3.2 EQUIPMENT PACKING LOG

Unpack the equipment and check for any damage that may have occurred during transit. Save the original shipping container for returns due to damage or warranty claims. Check that each item on the packing slip has been shipped in the container. Verify that the equipment display and backlighting configuration are the same as those ordered.

#### 3.3 TRANSCEIVER INSTALLATION

The TFM-138 Series Transceivers are designed to be Dzus mounted and should be installed in conjunction with a IN-150 installation kit. See Figure 3-1 for an outline drawing of the unit with dimensions to facilitate the installation.

#### 3.4 INSTALLATION KIT - CONTENTS

The IN-150 installation kit consists of:

1. One 15 pin Cannon D mating connector (female) complete with crimp pins and hood.
2. One BNC antenna mating RF connector (male) and hood.

#### 3.5 ANTENNA INSTALLATION

Antenna, P/N AT-150 may be obtained from Technisonic Industries Limited or a suitable equivalent may be utilized with the TFM-138 Series transceivers. The antenna should be mounted on the bottom of the aircraft whenever possible. Consult with instructions provided with the antenna. Connect RF cable from antenna to the back of the TFM-138 Series unit by utilizing the BNC mating connector provided in the installation kit.

#### 3.6 INSTALLATION - PIN LOCATIONS AND CONNECTIONS

The pin numbers and locations for the 15 pin Cannon D located on the rear of the TFM-138 Series transceivers are shown below. Pin connections are in provided in TABLE 3-1.

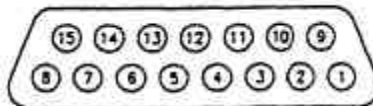

Transceiver mounted view of 15 pin connector

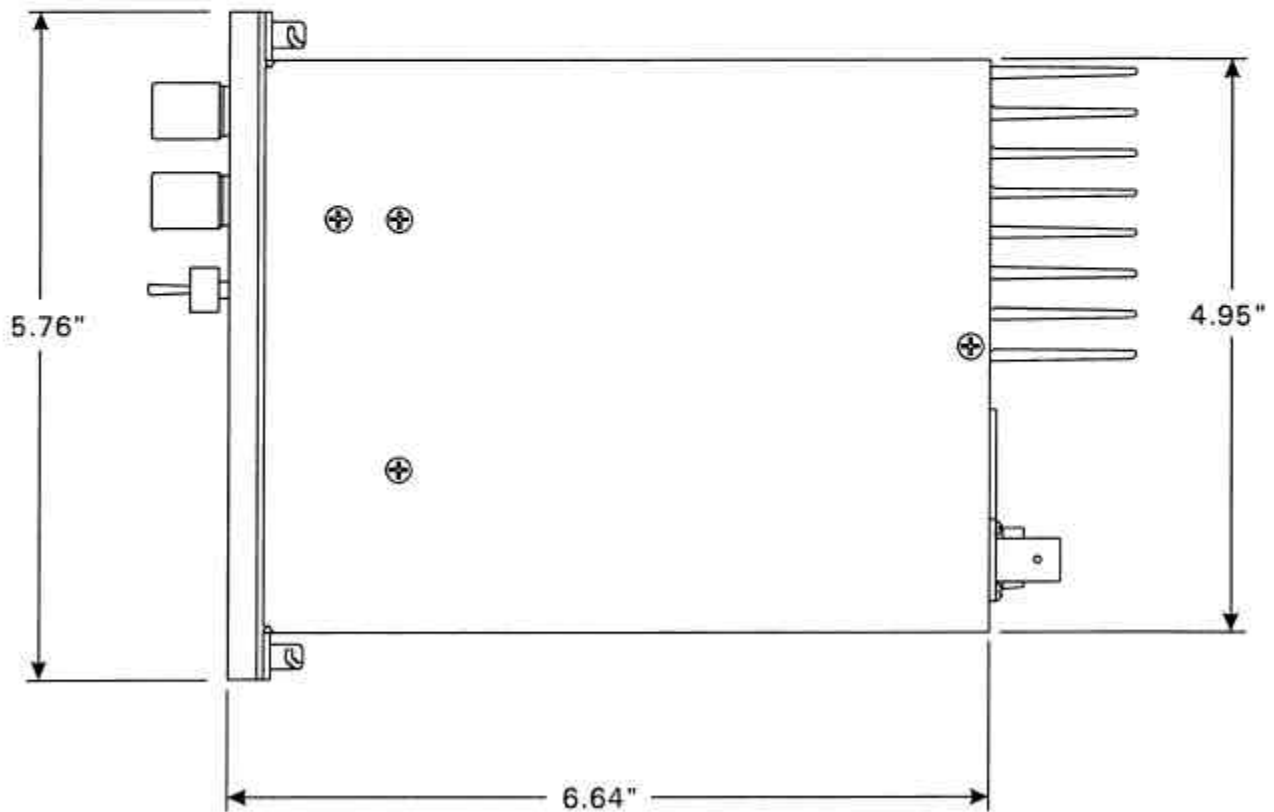
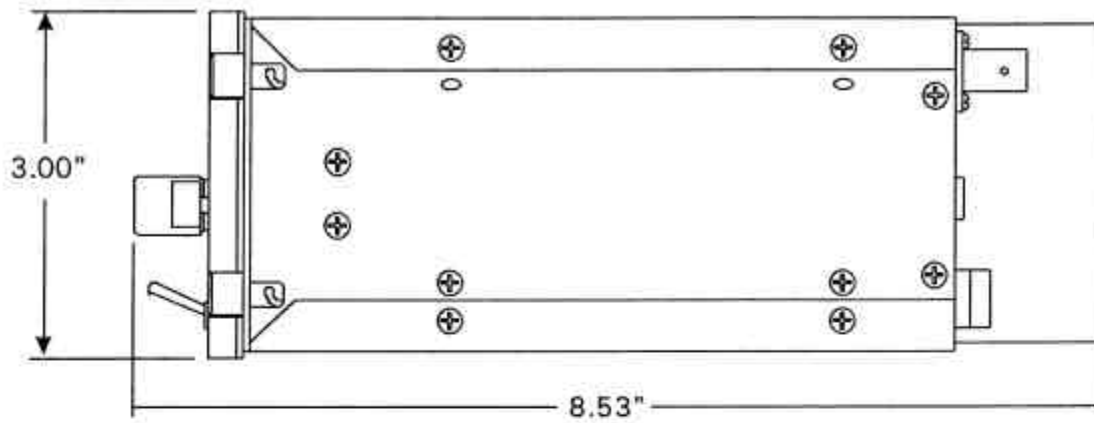

FIGURE 3-1 Outline Drawing for Model TFM-138 Series Transceivers



### 3.6 INSTALLATION - PIN LOCATIONS AND CONNECTIONS (continued)

TFM-138 Series Transceivers 15-Pin D Connections	
<u>Pin #</u>	<u>Description</u>
1	600 Ohm Output
2	Data Output
3	Panel Lighting (28VDC or 5VAC)
4	Memory UP/PC Download Input
5	Memory Down/PC Download Input
6	Mic Signal Input
7	Main Power + 28VDC
8	Main Ground
9	4 ohm Speaker Output
10	4 ohm/600 ohm Output Ground
11	Data Input
12	PC Download Input
13	PTT (Ground Keying)
14	Main Power + 28VDC
15	Main Ground

**TABLE 3-1**

### 3.7 WIRING INSTRUCTIONS

Figure 3-2 shows all required connections and recommended wire sizes for the TFM-138 Series Transceivers.

#### 3.7.1 Main Power + 28VDC

The main power + 28VDC ( $\pm 15\%$ ) is connected to pins 7 and 14 of the transceiver. Both pins should be connected.

#### 3.7.2 Main Ground

Ground connections for the transceiver are made on pins 8 and 15. Both pins should be connected.

#### 3.7.3 PTT (Ground Keying)

The PTT line is connected to pin 13 and should be floating when the transceiver is in receive mode, and grounded during transmit mode.

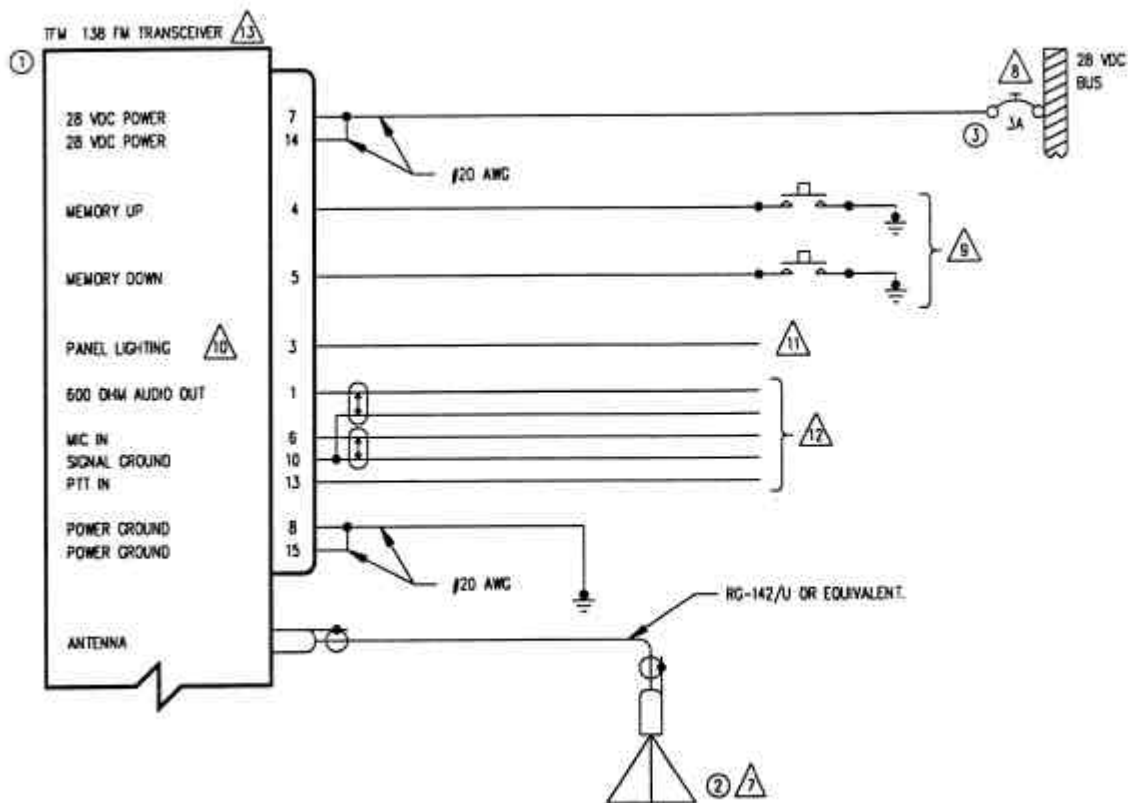

QTY	ITEM	PART NUMBER	DESCRIPTION	SPEC	MATERIAL
1	1	TFM-138, 138A, 138B	VHF/FM COMMUNICATIONS TRANSCEIVER	TECHNISONIC INDUSTRIES LIMITED	
1	2	AT-150	ANTENNA	TECHNISONIC INDUSTRIES LIMITED	
1	3	7274-11-3	CIRCUIT BREAKER, 3 AMPS	KLIXON	

NOTES:

- 1) ALL WIRE IAW MIL-W-22759 UNLESS OTHERWISE SPECIFIED.
  - 2) ALL CABLE IAW MIL-C-27500 UNLESS OTHERWISE SPECIFIED.
  - 3) COAXIAL CABLE IAW MIL-C-17 UNLESS OTHERWISE SPECIFIED. DO NOT USE COAX WITH PVC INSULATION.
  - 4) FABRICATION & INSTALLATION OF WIRING HARNESS IAW AC 43.13-1A CHAPTER 11, SECTION 3, PARA 445 TO 462 AND SECTION 7.
  - 5) GROUNDING AND BONDING IAW AC 43.13-1A CHAPTER 11, SECTION 3, PARA 452.
  - 6) ALL SINGLE WIRE TO BE #22 AWG MINIMUM AND ALL SHIELDED WIRE TO BE #24 AWG MINIMUM, UNLESS OTHERWISE SPECIFIED.
- 7) INSTALLATION OF ANTENNA IAW AC 43.13-1A CHAPTER 2, SECTION 3, CHAPTERS 5 & 6, AND AC 43.13-2A CHAPTER 3. IF POSSIBLE, THE ANTENNA SHOULD BE LOCATED A MINIMUM OF 12 FT FROM AIRCRAFT NAVIGATION RECEIVER ANTENNAS AND A MINIMUM OF 4 FEET FROM AIRCRAFT COMMUNICATIONS AND ELT ANTENNAS. BE CAREFUL NOT TO CHOSE SEPARATIONS THAT CLOSELY APPROXIMATE 1/4 OR 1/2 OR WHOLE NUMBER MULTIPLES OF THE NAVIGATION OR COMMUNICATIONS SYSTEM WAVELENGTH.
- 8) AN EQUIVALENT CIRCUIT BREAKER OR FUSE MAY BE USED.
- 9) THE MEMORY UP/DOWN PUSH BUTTONS ARE OPTIONAL.
- 10) THE TFM 138(A)(B) IS AVAILABLE WITH 28V OR 5V PANEL LIGHTING. CHECK THE CONFIGURATION CONTROL LABEL FOR THE CORRECT VOLTAGE.
- 11) CONNECT TO THE APPROPRIATE AIRCRAFT DIMMING BUSS.
- 12) CONNECT TO THE AIRCRAFT AUDIO SYSTEM OR STAND-ALONE HEADSET JACKS.
- 13) INSTALLATION OF TRANSCEIVER IAW AC 43.13-1A CHAPTER 2, SECTION 3 AND AC 43.13-2A CHAPTER 2. PR 3 1/2 DZUS RAIL OR EQUIVALENT MAY BE USED.
- 14) TEST THE SYSTEM IN ACCORDANCE WITH THE POST-INSTALLATION TEST PROCEDURE IN THE INSTALLATION AND OPERATING INSTRUCTIONS MANUAL.
- 15) REFER TO THE AIRCRAFT STRUCTURAL REPAIR MANUAL AND THE MAINTENANCE MANUAL FOR INSTRUCTIONS AND INFORMATION PERTINENT TO THIS INSTALLATION.
- 16) THE USE OF RED DISPLAYS SHOULD BE MINIMIZED OR AVOIDED SO AS NOT TO DETRACT FROM THE ATTENTION GETTING CHARACTERISTICS NEEDED IN WARNING AND CAUTION ANNUNCIATORS. RED SHOULD BE USED TO ANNUNCIATE EMERGENCY CONDITIONS REQUIRING IMMEDIATE RESPONSE BY THE FLIGHT CREW. UNITS WITH RED DISPLAYS SHOULD NOT BE LOCATED IN CLOSE PROXIMITY TO WARNING AND CAUTION ANNUNCIATORS. THE INSTALLATION OF UNITS WITH RED DISPLAYS MUST BE EVALUATED ON A CASE BY CASE BASIS TO ENSURE THAT THE EFFECTIVENESS OF THE WARNING AND CAUTION ANNUNCIATORS IS NOT ADVERSELY AFFECTED.

FIGURE 3-2 Wiring Connections for TFM-138, 138A, 138B Transceiver

### **3.7.4 Front Panel Back Lighting**

Front panel back lighting connection should be made on pin 3 of the transceiver. The opposite end of this lead should be connected to the panel lighting system of the aircraft. Before connecting, verify the required panel lighting voltage (28 VDC or 5VAC) on the transceiver configuration control label.

### **3.7.5 Audio Outputs (600 ohms and 4 ohms)**

The audio output from pin 9 can be used to drive a 4 ohm speaker up to 2.5 watts. Audio output from pin 1 is 600 ohms, 0.5 watts maximum.

### **3.7.6 Audio Output Ground**

Pin 10 is the ground for both the 4 ohm and 600 ohm audio output signals on pins 9 and 1.

### **3.7.7 Mic Signal Input**

The microphone input signal is to be provided on pin 6, utilizing shielded wire with the shield grounded to pin 10.

### **3.7.8 Memory Up/Memory Down**

Remote scrolling through the 120 (or 25 in the TFM-138) memory positions can be achieved by providing a ground to pins 4 (up) and 5 (down) through a momentary contact cyclic switch.

### **3.7.9 Data Input**

Data communications equipment requiring direct access to the modulator and discriminator can be connected via pins 2 and 11. Data cannot be transmitted in CANADA unless equipment is approved for use with the TFM-138 Series unit by the communications regulatory authority.

## **3.8 INTERNAL ENABLE/DISABLE JUMPER**

The programming and direct frequency entry modes can be disabled by removing the internal enable/disable jumper. Removal of this jumper will prevent operation on any frequencies other than those programmed in the 120 (or 25) memory positions and two guard receiver memory positions.

The transceiver is always shipped with this jumper in the entry enable position. To place the jumper in the disable position:

1. Remove and retain the seven (7) No. 4-40 screws securing the bottom cover of the transceiver to its chassis.
2. Remove and retain the four (4) No. 4-40 screws securing the guard receiver PCB module in the chassis tray. Remove the guard receiver module from the chassis tray.
3. Remove and retain the two (2) screws securing the fuse board. Remove and retain the five (5) screws securing the chassis tray to the main chassis. Remove the chassis tray.
4. You should now have access to the Microprocessor Control Unit (MCU) PCB Module (See Figure 3-3). Remove the enable/disable jumper from pins 3 and 4 of J15.
5. Reverse steps 1 through 3 and secure all screws to re-assemble the transceiver.

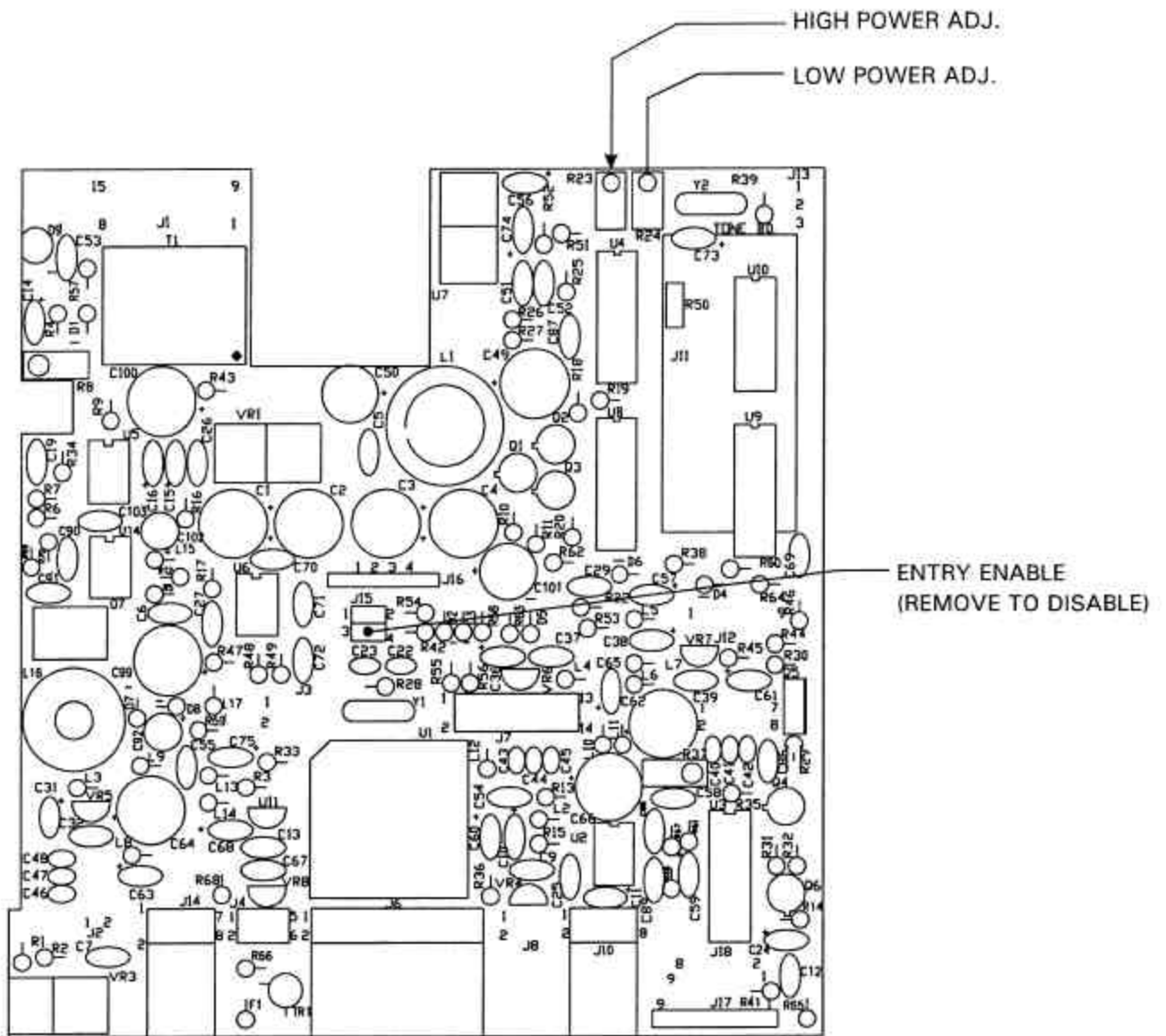

Microprocessor Control Unit (MCU) PCB Module

- Notes: R23 is High Power Adjustment
- R24 is Low Power Adjustment
- J15 Jumper between pins 3 and 4 for Entry Enable
- Remove for Entry Disable

FIGURE 3-3 Internal Enable/Disable Jumper and Transmit High/Low Power Adjust Locations

### **3.9 TRANSMITTER POWER ADJUSTMENTS**

The transmitter power is adjusted to a maximum of 10 watts in high power mode and 1 watt in low power mode over the transceiver operating bandwidth at the factory. If transmitter RF power re-adjustment is required, perform as follows:

1. Remove bottom cover as described in the previous paragraph (3.8). Access to the two adjustment potentiometers on the Microprocessor Control Unit (MCU) PCB Module is provided by two access holes located at the back of the chassis tray.
2. Connect an RF through-line wattmeter to the antenna connector. Set the operating frequency to 156.000 MHz and key the transmitter.
3. In low power mode, set the low power adjustment potentiometer R24 to produce 1.0 watt of RF output power (See Figure 3-3).
4. In high power mode, set high power adjustment potentiometer R23 to produce 9.5 watts of RF output power.
5. Verify that the RF output power is between 9 and 10 watts on 138.000 MHz, 162.000 MHz and 174.000 MHz.
6. Replace bottom cover as described in the previous paragraph (3.8).

### **3.10 TRANSMITTER MICROPHONE LEVEL ADJUSTMENT**

1. Set the transceiver operating frequency to 156.000 MHz and connect an appropriate test receiver to the RF output connector. Ensure that the output of the transceiver is terminated into a proper dummy load.
2. Key the transmitter and input a -10 dBm (0.25 VRMS), 1 KHz audio signal into the microphone input.
3. Adjust the microphone level potentiometer (R8 on MCU module) through the access hole located on the right side of the chassis (see Figure 3-4) to produce a 3.5 KHz deviation.
4. Verify that the deviation is at least 3 KHz on the following frequencies: 138.000 MHz, 162.000 MHz and 174.000 MHz.

### **3.11 TRANSMITTER SIDETONE LEVEL ADJUSTMENT**

1. Set the transceiver operating frequency to 156.000 MHz and connect an appropriate test receiver to the RF output connector. Ensure that the output of the transceiver is terminated into a proper dummy load.
2. Key the transmitter and input a -10 dBm (0.25 VRMS), 1 KHz audio signal into the microphone input.
3. Adjust the sidetone level potentiometer (R37 on MCU module) through the access hole located on the left side of the chassis (see Figure 3-4) to produce a + 3.0 dBm (1.0 VRMS) 600 ohm audio output.

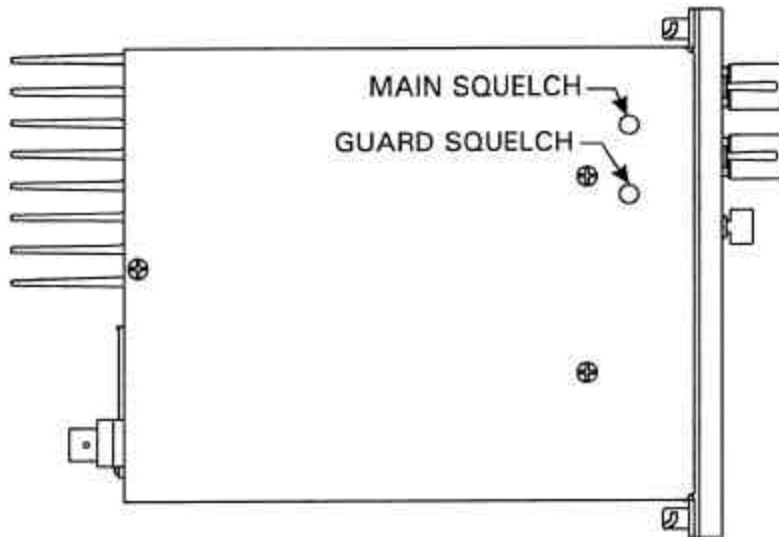
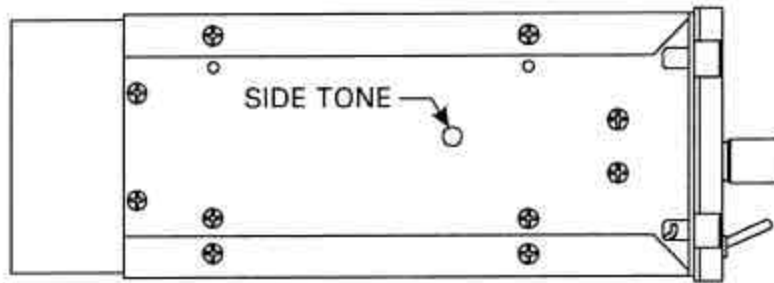
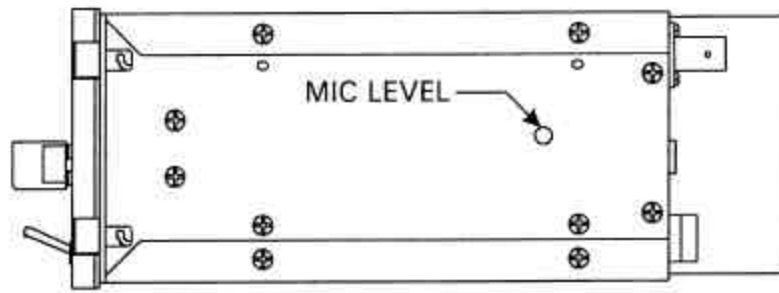

FIGURE 3-4 Microphone and Sidetone Level, Main and Guard Squelch Adjustment Access Holes

### 3.12 MAIN AND GUARD SQUELCH ADJUSTMENT

The squelch on both the main and guard receivers is factory set to open at approximately 0.5 microvolts. This adjustment can be made or altered to suit local conditions as follows:

1. Set the main receiver of the transceiver to 156.000 MHz. Connect a signal generator to the antenna input of the transceiver.
2. Set the signal generator to produce a  $\pm 3$  KHz deviation with a 1 KHz tone on 156.000 MHz. Increase the signal generator RF level from 0.1  $\mu$ V until the squelch indicator LED is on. Verify the receiver SINAD ratio is between 12 and 14 dB.
3. If not, re-adjust main receiver squelch potentiometer, R3 through the access hole located on the bottom of the transceiver chassis (see Figure 3-4).
4. Repeat the above procedure to adjust the guard receiver squelch setting using guard receiver squelch adjustment potentiometer, R4 (see Figure 3-4).

### 3.13 TRANSMITTER DEVIATION ADJUSTMENT

1. Remove and retain the eight (8) No. 4-40 screws securing the top cover of the transceiver to its chassis. You should now have access to the Main Rx/Tx Module.
2. Set the transceiver operating frequency to 156.000 MHz and connect an appropriate test receiver to the RF output connector. Ensure that the output of the transceiver is terminated into a proper dummy load.
3. Key the transmitter and input a +10 dBm (2.5 VRMS), 1 KHz audio signal into the microphone input.
4. Adjust the wideband deviation limit potentiometer, R30 on the main Rx/Tx module (see Figure 3-5) to produce a  $\pm 4.45$  KHz deviation. **For TFM-138 only:** Adjust the narrowband deviation limit potentiometer, R76 on the main Rx/Tx module to produce a  $\pm 2.2$  KHz deviation. (All narrowband adjustments for TFM-138B only).
5. Verify that the deviation does not exceed  $\pm 5$  KHz for wideband and  $\pm 2.5$  KHz for narrowband on the following frequencies: 138.000 MHz, 162.000 MHz and 174.000 MHz. Re-adjust R30 or R76 as required, if the deviation exceeds  $\pm 5$  KHz or  $\pm 2.5$  KHz, respectively.
6. Place top cover on transceiver chassis and secure all eight (8) screws.

### 3.14 GUARD RECEIVER AUDIO LIMIT FEATURE

Upon special request, 1 mW of guard receiver audio bleed with the guard volume control in the fully CCW (OFF) position, can be provided. This feature can be disconnected as follows:

1. Remove and retain the seven (7) No. 4-40 screws securing the bottom cover of the transceiver to its chassis.
2. Find the jumper located at the bottom of the front panel is connected between the CCW position of the guard audio potentiometer (R2) and ground. Remove this jumper.
3. Replace the bottom cover of the transceiver and secure with the seven (7) screws removed in step 1.

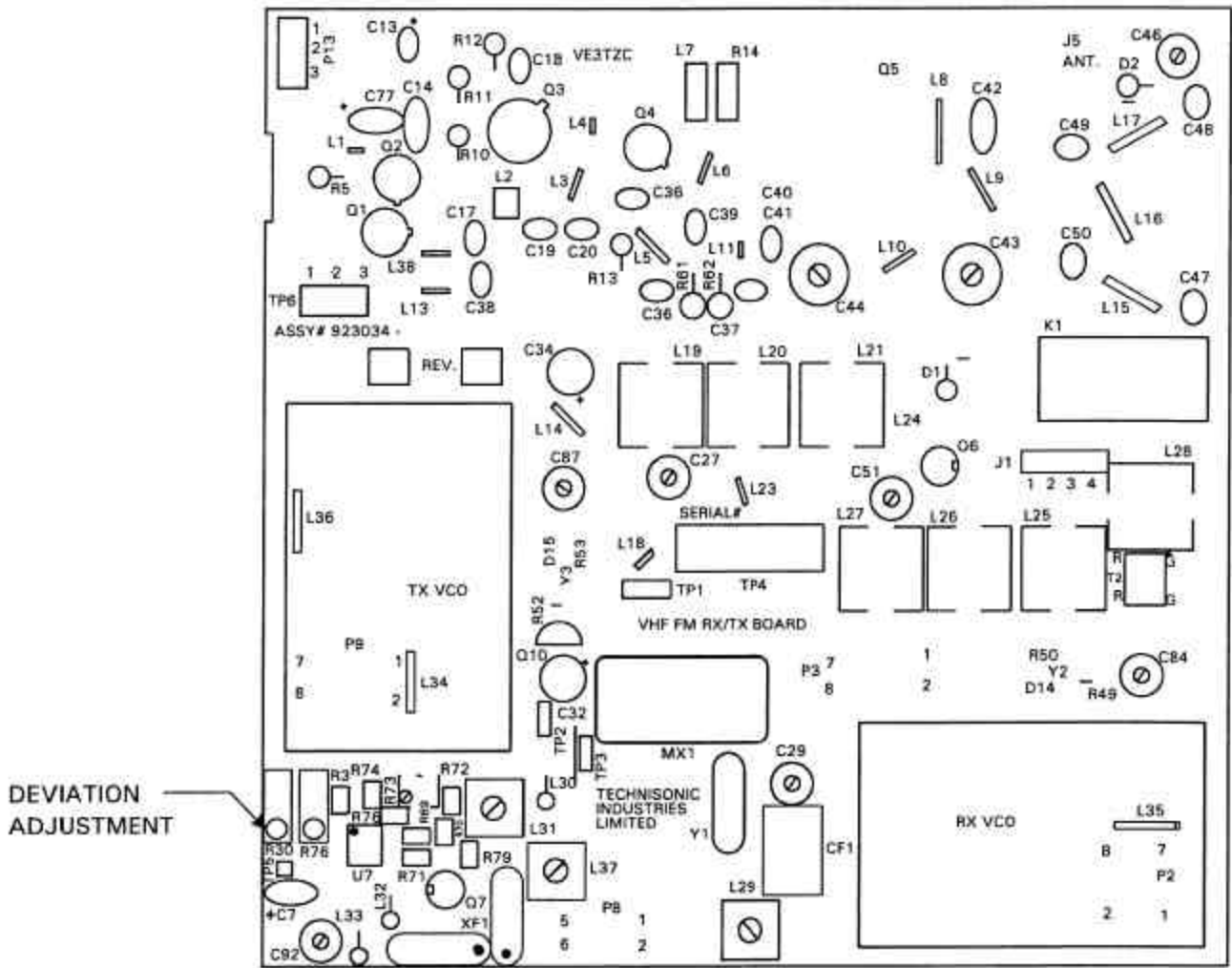

**Main Receiver/Transmitter PCB Module**

Notes: R30 is for 5.0 KHz (wideband) Deviation Adjustment  
 R76 is for 2.5 KHz (narrowband) Deviation Adjustment  
 (Narrowband adjustment applicable to TFM-138B only)

**FIGURE 3-5 Deviation Adjustment Potentiometer Location**



## APPENDIX TO "INSTALLATION INSTRUCTIONS" POST INSTALLATION EMI TEST

### PURPOSE

The purpose of this test is to identify any interference that the TFM-138, TFM-138A or TFM-138B may cause with existing aircraft systems. For simplicity all TFM-138 model variations will be referred as TFM-138 series transceivers in this document.

### TEST CONDITIONS

The TFM-138 series transceiver should be installed and function tested. The antenna VSWR should be checked. A forward/reverse power check with a in-line wattmeter should show no more than 10% reflected power. For the following tests, insure that the power switch is in the high position.

### METHODOLOGY

Most of the EMI tests can be accomplished on the ground. In some cases flight testing is required or is easier. If the aircraft is approved for IFR operations, then it is mandatory that interference between the TFM-138 series Airborne FM and the approach aids be checked in flight.

The GPS should be operational and navigating with at least the minimum compliment of satellites. The VHF comm should be set to the frequencies indicated with the squelch open. VOR/ILS/GS receivers should be set to the frequencies indicated and selected for display. If possible, set up a VOR/ILS ramp test set on the frequencies indicated and adjust the output until the flags are out of view. The transponder and encoder should be monitored with ramp test equipment. If possible set the ADF to a nearby navigation station.

Modulate the TFM-138 series transmitter on the indicated frequencies for at least 20 seconds.

Observe the GPS for any degradation in satellite status or availability or flags. Listen for any noise or detected audio signals on the VHF comm(s). Listen for any noise or detected audio signals on the VOR/LOC receiver audio; look for any moment of flags or needles on the VOR/LOC/GS navigation display(s).

List the power plant, fuel and other electric instruments in the chart provided and note any anomalies that occur while transmitting. Assess the results.

If the aircraft is equipped with an autopilot or a stability augmentation system, then test fly the aircraft and verify that operation of the TFM-138 series transceiver does not have adverse effects on these systems. After checking for gross effects at a safe altitude, fly an approach with each of the different navigation systems coupled to the autopilot (ILS, GPS ETC.) and look for any anomalies.

### RESULTS

If the installed system passes all of the applicable EMI tests, then no further action is required. If interference is observed then the interference must be assessed against the appropriate standards of airworthiness for the system in question. For example it is permissible for a VFR certified GPS to lose navigation capability while the TFM-138 series unit is transmitting, providing that it recovers properly and promptly, but it is not permissible for an IFR Approach certified GPS to be affected in the same way. A complete discussion of all the standards of airworthiness to be applied in assessing EMI effects is beyond the scope of this document.

**PROCEDURE**

- A. Operate the TFM-138 series transmitter on the following frequencies for at least 20 seconds. Observe the GPS for any degradation in satellite status or availability or flags.

FREQUENCIES	GPS #1		GPS #2	
	PASS	FAIL	PASS	FAIL
TFM 138				
143.180 MHZ				
143.1825 MHZ				
157.5000 MHZ				
157.5425 MHZ				

**NOTES:**

- B. Determine if the image frequency for the VHF Comm falls within the range of the TFM-138 series unit. If so, select a set of frequencies that will cause the TFM-138 series unit to be set as close as possible to the image frequency. Any one of the many possible sets will suffice. Record those values in the spaces provided in the following chart. Modulate the TFM-138 series transmitter on the following frequencies for at least 20 seconds. Listen for any noise or detected audio signals on the VHF comm.

Example - Bendix/King KY 196A:

The first IF frequency is 11.4 MHz. The L.O. is above the received frequency (high side injection), therefore the image frequency is 22.8 MHz above the selected frequency. Set the KY 196A to 120.000 MHz and the TFM-138 series Transceiver to 142.8000 MHz.

FREQUENCIES		RESULTS	
VHF #1	TFM-138 series	PASS	FAIL
135.975	138.0000		
121.150	157.5000		
131.250	157.5000		
Image:			

FREQUENCIES		RESULTS	
VHF #2	TFM-138 series	PASS	FAIL
135.975	138.0000		
121.150	157.5000		
131.250	157.5000		
Image:			

NOTES:

- C. Determine if the image frequency for the VOR/ILS Nav falls within the range of the TFM-138 series unit. If so, select a two sets of frequencies that will cause the TFM-138 series transceiver to be set as close as possible to the image frequency. Chose one set in the localizer frequency range, and one in the VOR frequency range. Record those values in the spaces provided in the following chart. Modulate the TFM-138 series transmitter on the following frequencies for at least 20 seconds. Listen for any noise or detected audio signals on the receiver audio; look for any moment of flags or needles on the navigation display.

FREQUENCIES		RESULTS	
VOR/ILS #1	TFM-138 series	PASS	FAIL
108.000	162.0000		
108.100	162.1500		
Image:			
Image:			

FREQUENCIES		RESULTS	
VOR/ILS #2	TFM-138 series	PASS	FAIL
108.000	162.0000		
108.100	162.1500		
Image:			
Image:			

NOTES:

- D. Modulate the TFM-138 series transmitter on the following frequencies for at least 20 seconds. Look for any moment of flags or needles on the navigation display.

FREQUENCIES		RESULTS	
G/S #1	TFM-138 series	PASS	FAIL
334.7 (108.1)	167.3500		

FREQUENCIES		RESULTS	
G/S #1	TFM-138 series	PASS	FAIL
334.7 (108.1)	167.3500		

NOTES

**NOTE:**

For the following tests, select a frequency at the top, middle and bottom of the range of the TFM -138 series transceiver.

Frequency #1 \_\_\_\_\_

Frequency #2 \_\_\_\_\_

Frequency #3 \_\_\_\_\_

- E. At a safe altitude engage the autopilot or stability augmentation system. Modulate the TFM- 138 series transmitter on the above frequencies for at least 20 seconds. Observe any effect on the autopilot or stability augmentation system.

Observations:

- F. Perform a coupled ILS approach to the aircraft's certified limits. Modulate the TFM- 138 series transmitter on the above frequencies for at least 20 seconds. Observe any effect on the autopilot. Repeat for each different system such as ILS #2, GPS, FMS ETC.

Observations:

- G. List the power plant, fuel and other electric instruments in the chart provided and note any anomalies that occur while transmitting. Assess the results.

STEP	SYSTEM	PASS	FAIL	NOTES
1	Xponder & Encoder			
2	ADF 1 & 2			
3	VG			
4	Compass			
5	Directional Gyro			
6	Oil Pressure			
7	Fuel Pressure			
8	Oil Temp			
9	Amps			
10	Bus Voltage			

STEP	SYSTEM	PASS	FAIL	NOTES
11	Fuel %			
12	Ng			
13	TOT			
14	Torque %			
15	Annunciators			
16	Digital Clock			



STEP	SYSTEM	PASS	FAIL	NOTES

STEP	SYSTEM	PASS	FAIL	NOTES

**NOTES:**