

# ACCESS/A™ AUDIO CONTROL SYSTEM

## MODELS: A770 & A775

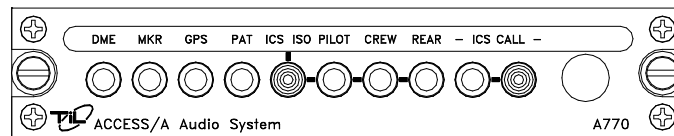
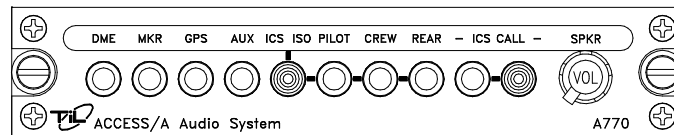
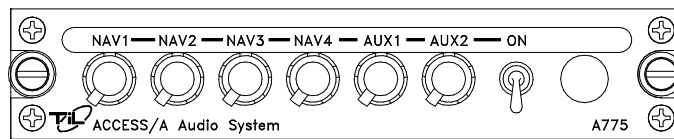
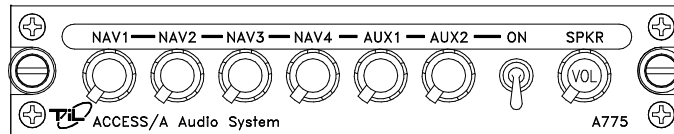

## Installation and Operating Instructions

TiL Document No.  
97RE214  
Rev. N/C Issue 1  
August 14, 1997

### Technisonic Industries Limited

240 Traders Blvd., Mississauga, Ontario L4Z 1W7 Tel: (905) 890-2113 Fax: (905) 890-5338  
www.til.ca

**WARRANTY INFORMATION**

---

The Model A770 and A775 Eyebrow Panels are under warranty for one year from date of purchase. Failed units caused by defective parts or workmanship should be returned for warranty service to:

**Technisonic Industries Limited**  
240 Traders Boulevard  
Mississauga, Ontario L4Z 1W7

Tel: (905) 890-2113  
Fax: (905) 890-5338

**TRADEMARK INFORMATION**

---

**ACCESS/A, ACCESS/D, ACCESS/R & ACCESS/F** are all trademarks of Technisonic Industries Ltd. and Sphere Research Corporation. All rights reserved. **ACCESS/x** family products use one or more processes or circuits that are **patent pending**.

## TABLE OF CONTENTS

SECTION 1	GENERAL DESCRIPTION	TiL DOCUMENT	97RE294
1.1	Introduction .....		1-1
1.2	Description .....		1-1
1.3	Purpose of Equipment .....		1-2
1.4	Model Variations .....		1-2
1.5	Technical Summary .....		1-5
SECTION 2	INSTALLATION INSTRUCTIONS		
2.1	General .....		2-1
2.2	Equipment Packaging Log .....		2-1
2.3	Wiring Requirements .....		2-1
2.4	Eyebrow Panel Installation & Drawings.....		2-1
2.5	Kit Contents.....		2-7
2.6	Pin Connections and Locations .....		2-8
2.7	Signal Sources.....		2-11
2.8	ICS ISO LIGHT/ICS CALL Installation .....		2-11
2.9	Speaker Level Connections .....		2-11
2.10	Main Power .....		2-11
2.11	Backlighting Power.....		2-12
2.12	Ground .....		2-12
2.13	Storage.....		2-12
2.14	Post Installation Adjustment Locations .....		2-13
2.15	Post Installation Adjustments.....		2-13
SECTION 3	OPERATION		
3.1	Front Panel Operator's Switches & Controls .....		3-1
3.1.1	Radio RX Selection/Level Control.....		3-2
3.1.2	ICS Isolation Functions .....		3-3
3.1.3	ICS Call Functions .....		3-4
3.1.4	Speaker Level Control .....		3-5
3.2	Special Signal Considerations .....		3-6
3.2.1	Direct Audio Connections .....		3-6
3.2.2	Sum Node Output .....		3-6
3.3	Changing Overlay Lighting & Radio Legends .....		3-7

**LIST OF TABLES**

1-1 A770 General Specifications ..... 1-4  
1-2 A775 General Specifications ..... 1-5

**LIST OF ILLUSTRATIONS**

1-1 A770 Audio Control - General View..... 1-3  
1-2 A775 Audio Control - General View..... 1-4  
2-1A A770 Outline Drawing ..... 2-3  
2-1B A775 Outline Drawing ..... 2-4  
2-2 System Installation Drawings- A770..... 2-5  
2-3 System Installation Drawings- A775..... 2-6

**SECTION 1****GENERAL DESCRIPTION****1.1 INTRODUCTION**

This publication provides operating and installation information on the Model **A770 and A775**, **ACCESS/A** Audio Control series “eyebrow” panels manufactured by Technisonic Industries Limited. These units are designed to provide high performance cockpit audio control in high noise installations. The **A770** provides a convenient centralized location for system level functions (ICS routing and calling), as well as supplemental audio selections routed to a specific panel. The **A775** provides a variable input adjustment location to a specific panel, and both units can be used to implement many custom variations. These units are normally used in conjunction with other **ACCESS/A** family controls, such as the **A710** or **A711**, to provide expanded capability.

**1.2 DESCRIPTION**

The **A770** has pushbutton selectors for up to four additional groups of input signals, or for 3 input groups and an optional “patient headset” control for EMS applications. This headset disable function allows EMS operators to kill headset audio to a patient when information that would alarm the patient must be discussed over the common ICS system. The **A770** also provides ICS loop control, with three ICS isolation switches (pilot, crew, rear), and an ICS ISO status light to indicate tie/split status. The ISO indicator is GREEN when all units are tied together, and turns AMBER when any unit is split or isolated from the network. The ICS ISO status light is dimmed automatically by the panel dimmer, to avoid unwanted cockpit glare if mounted in the pilot’s field of vision

The **A770** has an ICS call button and light, which can be used to co-ordinate communication with a rear (out of sight) location; logic is a ground to indicate “called”. The **A770** can also have an optional speaker level control installed, as part of a complete system package, when used with the **A710** or **A711**.

The **A775** is a variable input control, and can be used to provide input adjustment for unusual sources or to permit special mixing configurations to be implemented. It can have up to 8 input controls, or 6 and a master on/off switch (default), or 6 and a master on/off switch, plus a speaker level control. It may also be configured with some **A770** features, and can have simple ICS tie/split functions as a custom unit. These two eyebrow panels allow basic control stations to have greatly expanded system functionality, ***without compromising essential harness compatibility and inter-operability within a fleet of aircraft***. The eyebrow panels can contain a wide variety of special and fully customized features to suit even the most complex installations unusual system requirements. Supplemental plugs on each unit provide even more customization flexibility, while retaining basic unit testability and compatibility.

Both units are compact (3 hole) Dzus mounted enclosures, and can be provided in either matte black or Cessna Cadet Gray, to match most installations. Legends are provided by Lexan panel inserts, and are easily customized either at TiL, or at outside aircraft or avionics completion centers, without requiring re-manufacture of the lighted overlay assembly. These Lexan inserts can be changed at any time, making the unit easily upgradeable in the field as requirements change.

Both units are essentially passive switching assemblies, and work with or without power (except for any system indicator lights).

### 1.3 PURPOSE OF THE EQUIPMENT

The **A770 and A775 ACCESS/A** Audio Control Eyebrow Panels are designed to provide added capability to centralized audio management and control within an airborne communications environment. This includes radio selection, intercom switching and calling, and crew management. These units have been packaged to minimize size and weight characteristics and are ideally suited for helicopter installations, or any other Dzus rail panel location. These products are also compliant with all **TSO-C50c**, **DO-214** and **DO-160C** applicable categories relating to frequency response, cross-talk, vibration, humidity, temperature, altitude and general environmental conditions in an airborne environment.

### 1.4 MODEL VARIATION

The **A770** and **A775** come in two basic lighting configurations. A +28VDC panel lighting version and a +5VDC panel lighting version. Operationally the two are identical. The color of the solid-state backlighting is green-yellow, at approximately 565nm wavelength. NVG compliant (IR filtered) lighting is also available on request, add "NVG" suffix to dash number. Panel front color may be either Cessna Cadet gray or matte black. The default configuration is black, with 28VDC backlighting. Units may also be supplied with or without **speaker volume controls** (far right hand pot position). See the ACCESS/A price list for model numbers and availability or different versions. The most common variations are summarized below:

**A770 = 9xxxxx** - (dash number)

**A775 = 9xxxxx** - (dash number)

#### **Dash Numbers:**

---

<b>-2</b>	Black Panel	28VDC Lighting
<b>-4</b>	Black Panel	5VDC Lighting

#### **special order:**

<b>-1</b>	Gray Panel	28VDC Lighting
<b>-3</b>	Gray Panel	5VDC Lighting

**-nNVG** any version

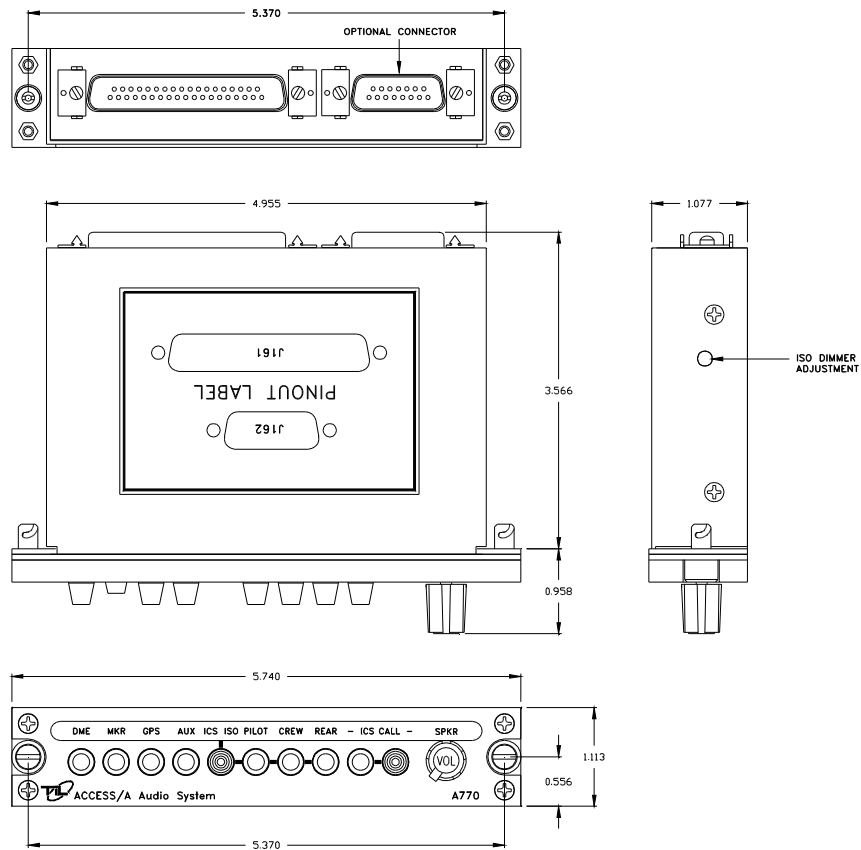
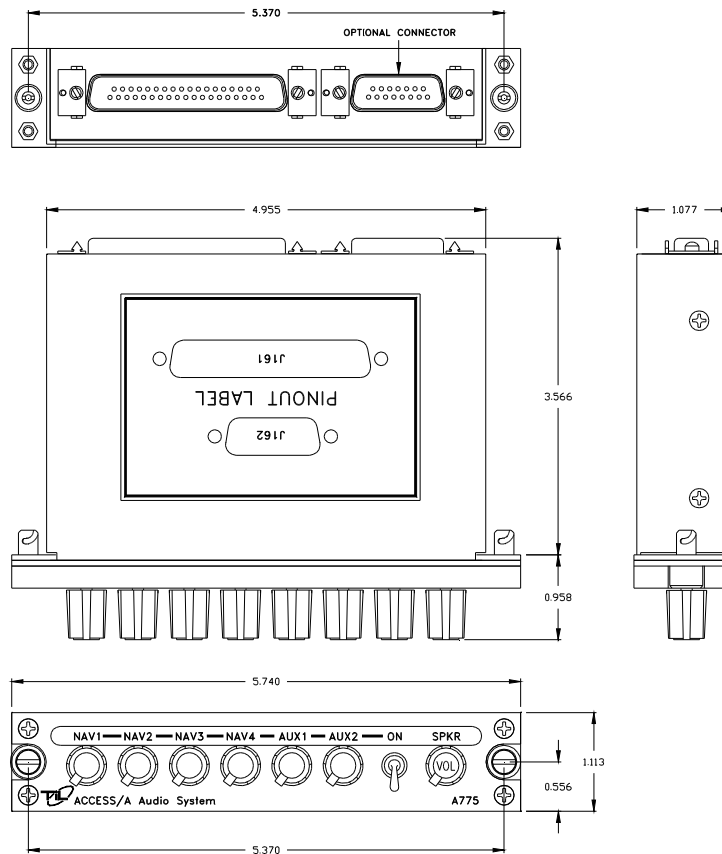

FIGURE 1-1 A770 ACCESS/A EYEBROW PANEL - GENERAL VIEW



**FIGURE 1-2 A775 ACCESS/A EYEBROW PANEL- GENERAL VIEW**



**1.5 TECHNICAL SUMMARY**

A summary of the relevant electrical, operational, mechanical and physical characteristics of the eyebrow panels are given in **Table 1-1 and 1-2**, General Specifications.

<b>TABLE 1-1 A770 GENERAL SPECIFICATIONS</b>	
<b>MODEL A770</b>	
ACCESS/A Audio Controller Eyebrow Panel	
<b>PHYSICAL CHARACTERISTICS:</b>	
Width (max.).....	5.75 inches
Height (max.).....	1.125 inches
Depth.....	3.5 inches
Weight.....	9.6 oz. (.27Kg)
Mounting .....	Standard Dzus, 2 fasteners
<b>POWER SOURCE REQUIREMENTS:</b>	
DC Voltage (Negative Ground) .....	28 Vdc(-20%+15%)
DC Current.....	60 mA (nominal)
Backlighting Input:	
Standard.....	28 Vdc @ 30 mA
Optional.....	5 Vdc @ 150 mA
<b>TECHNICAL CHARACTERISTICS:</b>	
Input Impedance (Normal Mode, any RX input).....	1.55K Ohms (typical)
Inputs available .....	up to 9; 6 switched (4 switches), 3 direct
ICS Node Inputs available.....	up to 3; pilot, crew and rear
Deselected input isolation (switch OFF).....	better than -65 dB
Speaker Level Control (optional).....	10K audio taper control
ICS Call Circuit.....	Outputs and expects a GROUND
ICS ISO Output .....	Outputs +28V input via 15 Ohm resistor when station is SELECTED
<b>ENVIRONMENTAL:</b>	
Temperature (operating) .....	-40°C to +70° Celsius
Temperature (survival non-operating) .....	-55°C to +85° Celsius
Humidity .....	95% Non-condensing
Shock .....	12 g (any axis)
Altitude .....	15,000 feet

**TABLE 1-2 A775 GENERAL SPECIFICATIONS**

**MODEL A775**

ACCESS/A Audio Controller Eyebrow Panel

**PHYSICAL CHARACTERISTICS:**

Width (max.).....	5.75 inches
Height (max.).....	1.125 inches
Depth.....	3.5 inches
Weight.....	9.6 oz. (.27Kg)
Mounting .....	Standard Dzus, 2 fasteners

**POWER SOURCE REQUIREMENTS:**

DC Voltage (Negative Ground) .....	Not Required
DC Current.....	Not Required
Backlighting Input:	
Standard.....	28 Vdc @ 20 mA
Optional.....	5 Vdc @ 100 mA

**TECHNICAL CHARACTERISTICS:**

Input Impedance (Normal Mode, any RX input).....	1.55K Ohms (typical)
Inputs available .....	up to 9; 8 variable (6 default), 1 direct
ICS Node Inputs available (optional).....	up to 3; pilot, crew and rear
Deselected input isolation (Main Switch OFF) .....	better than -65 dB
ICS Call Circuit (optional).....	Outputs and expects a GROUND
Speaker Level Control (optional, requires one variable input) .....	10K audio taper control

**ENVIRONMENTAL:**

Temperature (operating) .....	-40°C to +70°Celsius
Temperature (survival non-operating) .....	-55°C to +85°Celsius
Humidity .....	95% Non-condensing
Shock .....	12 g (any axis)
Altitude .....	15,000 feet

**SECTION 2****INSTALLATION INSTRUCTIONS****2.1 GENERAL**

This section contains information and instructions for the correct installation of the **A770 and A775, ACCESS/A** Audio Control Eyebrow Panels.

Make certain that the unit is correctly operating in accordance with the equipment user's requirements and manufacturer's specifications, prior to releasing the equipment for service.

**2.2 EQUIPMENT PACKING LOG**

Unpack the equipment and check for any damage that may have occurred during transit. Save the original shipping container for returns due to damage or warranty claims. Check that each item on the packing slip has been shipped in the container. Verify that the equipment's backlighting configuration is the **same as that required**.

**2.3 WIRING REQUIREMENTS**

Airframe wiring should be MS22759 Tefzel or Raychem 44 (81044) or 55 single or multi-conductor and shielded wire. Heatshrink solder sleeves (such as Raychem or equivalent) should be utilized for shield termination.

All Microphone audio input and output line connections should be made with 2 conductor/twisted pair shielded cables as illustrated. Receiver audio input lines should also be 2 conductor twisted pair shielded cables. The power and ground lines should be a minimum of #22 AWG (#20 preferred). Keying and all audio lines may be #24 AWG or larger.

 **CAUTIONS:**

**DO NOT** bundle **any low level audio lines with RF coaxial cables, 60 Hz or 400Hz AC inverter, motor, pump or blower wiring**, which can cause noise coupling between the various systems, especially during RF transmission or pump/blower mechanical operation. Maintain as much distance as possible from these types of wire bundles.

Note that there is really **no effective field-installable shielding for magnetic coupling** (which occurs at high currents), and the only suitable prevention for this type of interference is **distance** between the interfering lines. Shielded wiring is effective **only** for electrostatic coupling, or voltage driven interference.

**2.4 ACCESS/A EYEBROW PANEL INSTALLATION**

The **A770 and A775 ACCESS/A** Eyebrow Panels are designed to be Dzus mounted and should be installed in conjunction with an **IN-A770** installation connector kit. See **Figure 2-1** for an outline drawing of the units with dimensions, to facilitate the installation.

**☑ CABLE CLEARANCE:**

Allow **at least 2.5"** of additional rear clearance for mating connectors and hoods (side routing), or 3.0" (back routing). Cables should be long enough to **permit the unit to be removed** from the panel, and the connectors to be easily disengaged. **DO NOT** dress or strap the mating cables so that front removal is impossible, or the unit cannot be removed for service or adjustment in the field.

**☑ PANEL MODIFICATIONS:**

**Modified panel legends, panel lighting, NVG compatibility, or overlay colors** are also possible, please see the price list for a full summary of options and part numbers. Overlays and legends may be easily changed at low cost in the field with no special tools or service facilities required. Many custom variations are possible in these units, both in the field and at the factory.

**☑ SHIELD GROUNDS:**

**Shield ground connections** are made at the closest clean DC ground for the indicated input signal shield drains, and should give the shortest possible return for these lines. These shield lines may be daisy chained together, and a single wire from each cable brought out to the connector pin.

**☑ INTERNAL OPTIONS:**

All **configurable and variable options** of the **A770** and **A775** (input routing and control functions) can be set or changed simply by altering internal jumpers, but these changes **require opening the unit for access** to the required connections.

**DRAWINGS:**

System installation examples are given in the multi-page sections of **Figure 2-x**. These installation and mechanical drawings are available as OrCAD, or Windows Metafile "WMF" format free of charge to authorized TiL dealers and completion centers.

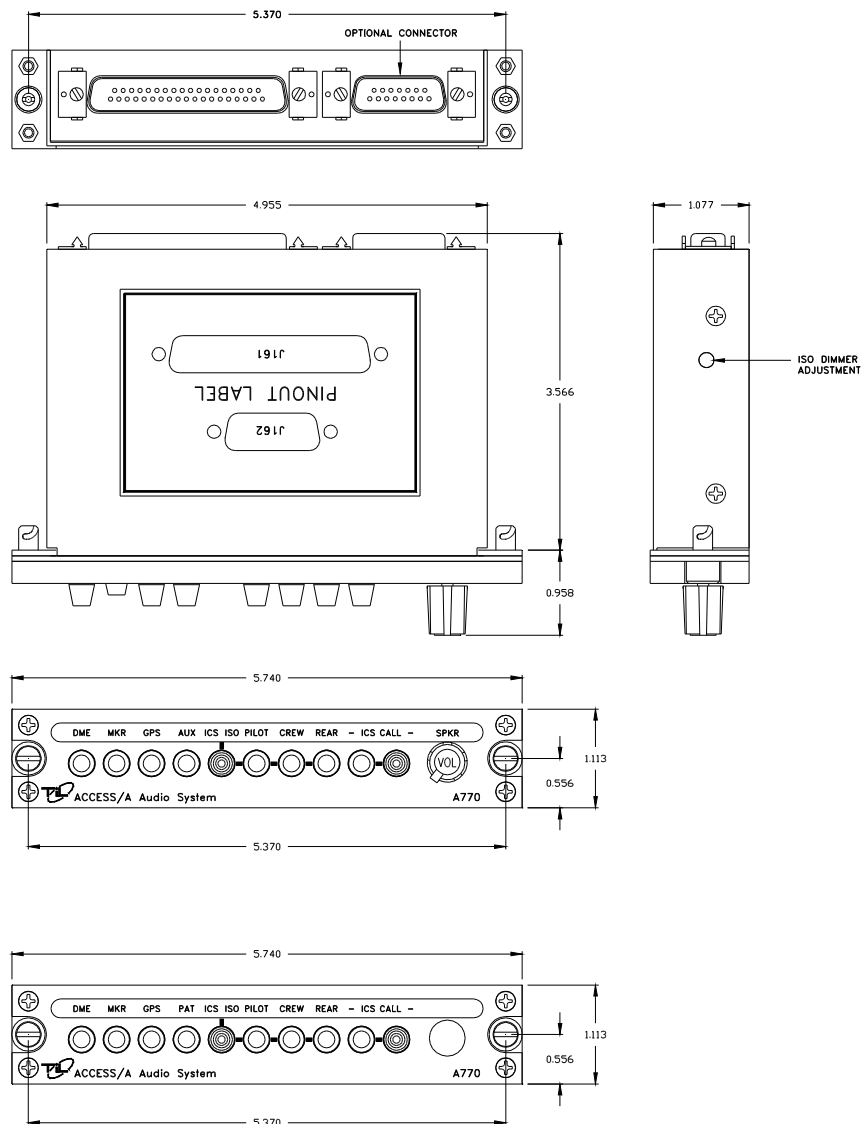

**FIGURE 2-1A Outline Drawing for Model A770 ACCESS/A Eyebrow Panel**

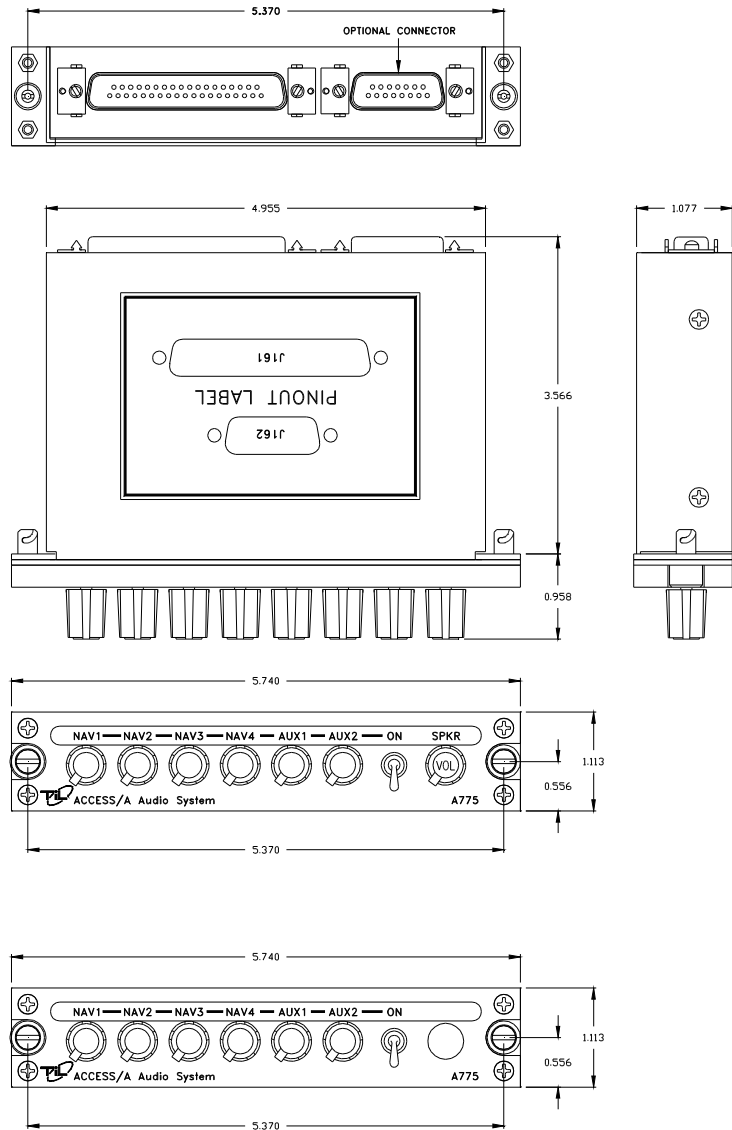

**FIGURE 2-1B Outline Drawing for Model A775 ACCESS/A Eyebrow Panel**

**The following page contains a full B size A770 installation drawing (fold-out)**

**Figure 2-2 A770**

THIS DRAWING CONTAINS DESIGN AND OTHER INFORMATION WHICH ARE THE PROPERTY OF TECHNISONIC INDUSTRIES LIMITED EXCEPT FOR RIGHTS EXPRESSLY GRANTED BY CONTRACT TO THE CANADIAN OR UNITED STATES GOVERNMENT MAY NOT, IN WHOLE OR IN PART, BE DUPLICATED OR DISCLOSED OR USED FOR MANUFACTURE OF PART DISCLOSED HEREIN, WITHOUT THE PRIOR WRITTEN PERMISSION OF TECHNISONIC INDUSTRIES LIMITED.

REVISIONS			
LTR	DESCRIPTION	DATE	APPR.

### A770 EYEBROW PANEL

#### RADIO SOURCE CONNECTIONS

- SOURCE 1 HI <<
- SOURCE 1 LO <<
- SOURCE 2 HI <<
- SOURCE 2 LO <<
- SOURCE 3 HI <<
- SOURCE 3 LO <<
- SOURCE 4 HI <<
- SOURCE 4 LO <<
- SOURCE 5 HI <<
- SOURCE 5 LO <<
- SOURCE 6 HI <<
- SOURCE 6 LO <<
- SOURCE 7 HI << UNSWITCHED
- SOURCE 7 LO <<
- SOURCE 8 HI << UNSWITCHED
- SOURCE 8 LO <<
- SOURCE 9 HI << UNSWITCHED
- SOURCE 9 LO <<

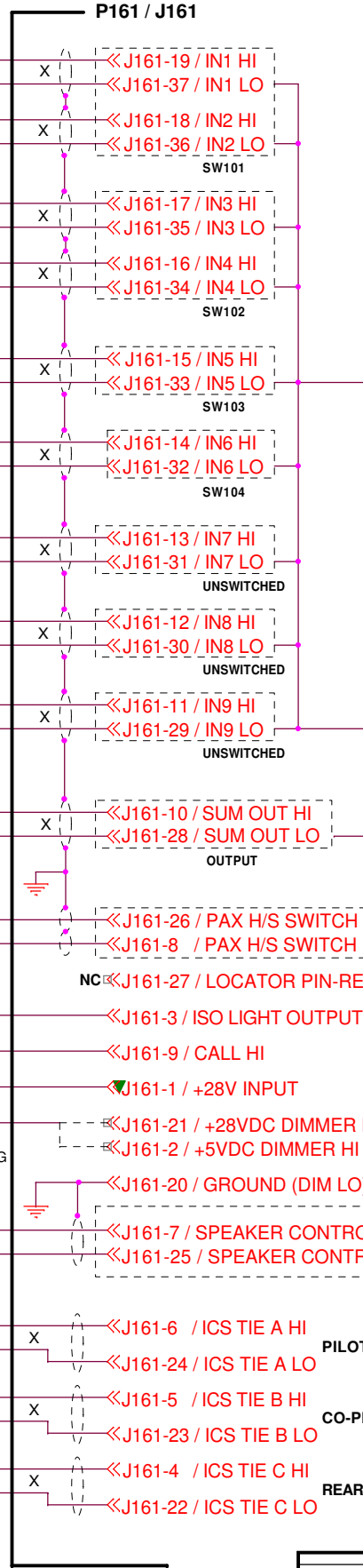

THIS CONNECTION SHOWN FOR REFERENCE ONLY, DO NOT MAKE IN HARNESS!

= FLOATING GROUND, NOT TIED TO LOCAL POWER SUPPLY COMMON.

- #### SWITCH FUNCTIONS
- S101- INPUTS 1 & 2
  - S102- INPUTS 3 & 4
  - S103- INPUT 5
  - S104- INPUT 6 OR PAX H/S SWITCH
  - S105- RESERVED
  - S106- PILOT ISO
  - S107- CREW ISO
  - S108- REAR ISO
  - S109- ICS CALL (MOMENTARY)
  - S110- RESERVED

TO A710 SERIES UNIT  
**J201-2 / SUM NODE HI <<**  
**J201-21 / SUM NODE LO <<**

LOCAL CONTROL THAT REQUIRES THE EXPANDED INPUT SELECTIONS. (MAY BE CONNECTED TO ONLY ONE CONTROL !)

A770 MIXER OUTPUT TO SUM NODE INPUT ON A710 SERIES UNIT

OPTIONAL CONNECTION FOR EMS INSTALLATIONS

**PATIENT H/S HI OUTPUT <<**  
**PATIENT H/S HI CONNECTION <<**

"ICS CONNECTED LAMP" (100mA MAX) TYPICALLY GREEN, AT REMOTE LOCATION

LP101  
Up to 2x 327/387

+28V SIGNAL LINE (INDICATES ICS IS CONNECTED) MAY BE USED TO CLARIFY STATUS AT REMOTE STATIONS.

ICS CALL (GOES LOW FOR CALL)

ALTERNATE CONNECTION TO SECOND A770  
**J161-9 / CALL HI <<**

SUPPLEMENTAL CONNECTION TO RELATED A710/A711  
**J102-10 / ALERT #6 <<**

TO A710 SERIES UNIT  
**J101-5 / SPKR VOLUME HI <<**  
**J101-43 / INT. GROUND <<**

- #### WIRE DEFINITIONS:
- SHIELDED WIRE, 24GA OR LARGER
  - SHIELD
  - SHIELDED, TWISTED PAIR, 24GA OR BIGGER
  - SIGNAL WIRE, 22GA OR LARGER

"ICS CALL" LIGHT AT REMOTE LOCATION

"ICS CALL" SWITCH AT REMOTE LOCATION

ICS CALL VOICE ALERT TRIGGER

S101  
N.O. PUSHBUTTON

+28VDC

CB101  
1A

DIMMER BUS

SELECT LIGHTING PIN

NC << J161-27 / LOCATOR PIN-REMOVE !

<< J161-3 / ISO LIGHT OUTPUT

<< J161-9 / CALL HI

<< J161-1 / +28VDC DIMMER HI

<< J161-2 / +5VDC DIMMER HI

<< J161-20 / GROUND (DIM LO)

<< J161-7 / SPEAKER CONTROL HI

<< J161-25 / SPEAKER CONTROL LO

INTERNAL JUMPER (A770) SELECTS WHICH SWITCH -PILOT-CREW-REAR- ACTIVATES THIS EXTERNAL LIGHT.

DIMMER BUS SENSING CIRCUIT CUTS FRONT PANEL ISO LIGHT INTENSITY FOR NIGHT FLYING. (THIS MAY BE PLACED IN PILOT'S FIELD OF VISION). FRONT PANEL ISO LIGHT IS GREEN WHEN ALL LINES ARE TIED, AMBER WHEN ANY LINE IS ISOLATED.

OPTIONAL CONNECTION, ONLY FOR A710/711 CONTROLS WITH REMOTE SPEAKER VOLUME CONNECTION ADDED TO RESERVED PIN. INTERNAL JUMPERS IN A770 MUST BE SET TO CONTROL THIS FUNCTION, AND PROPER POT (10K) MUST BE INSTALLED.

PILOT

CO-PILOT/CREW

REAR

TO A710 SERIES UNIT  
**J201-1 / ICS NODE HI <<**  
**J201-20 / ICS NODE LO <<**

TO A710 SERIES UNIT  
**J201-1 / ICS NODE HI <<**  
**J201-20 / ICS NODE LO <<**

TO A710 SERIES UNIT  
**J201-1 / ICS NODE HI <<**  
**J201-20 / ICS NODE LO <<**

<< J161-6 / ICS TIE A HI  
<< J161-24 / ICS TIE A LO

<< J161-5 / ICS TIE B HI  
<< J161-23 / ICS TIE B LO

<< J161-4 / ICS TIE C HI  
<< J161-22 / ICS TIE C LO

Tolerances:	Date: 7July97
ALL DIMENSIONS ARE IN INCHES UNLESS SPECIFIED OTHERWISE STATED	Drawn: Walter Shawlee 2/SRC
### -> ±0.1	Date:
### -> ±0.01	Approved:
### -> ±0.001	Application / Used On: 973307-1
ANGLES -> 0.5°	
HOLE DIA -> ±0.003	

Size: C	Cage Code: 38546	DWG #: 975294	REV: A
Scale:	Print: Monday, July 07, 1997	Page: 1 of 1	

**TiL Technisonic Industries Ltd.**  
250 Watline Ave.  
Mississauga, Ontario L4Z 1P4

**A770 Eyebrow Panel Interconnect**  
A770Inst

HIGHEST DESIGNATION(S) USED				



**The following page contains a full B size A775 installation drawing (fold-out)**

**Figure 2.3 A775 Installation Drawing**

THIS DRAWING CONTAINS DESIGN AND OTHER INFORMATION WHICH ARE THE PROPERTY OF TECHNISONIC INDUSTRIES LIMITED EXCEPT FOR RIGHTS EXPRESSLY GRANTED BY CONTRACT TO THE CANADIAN OR UNITED STATES GOVERNMENT OR DISCLOSED OR USED FOR MANUFACTURE OR PART DISCLOSED HEREIN WITHOUT THE PRIOR WRITTEN PERMISSION OF TECHNISONIC INDUSTRIES LIMITED.

REVISIONS			
LTR	DESCRIPTION	DATE	APPR
B	PRODUCTION CHANGES	JULY 3/97	

### A775 EYEBROW PANEL

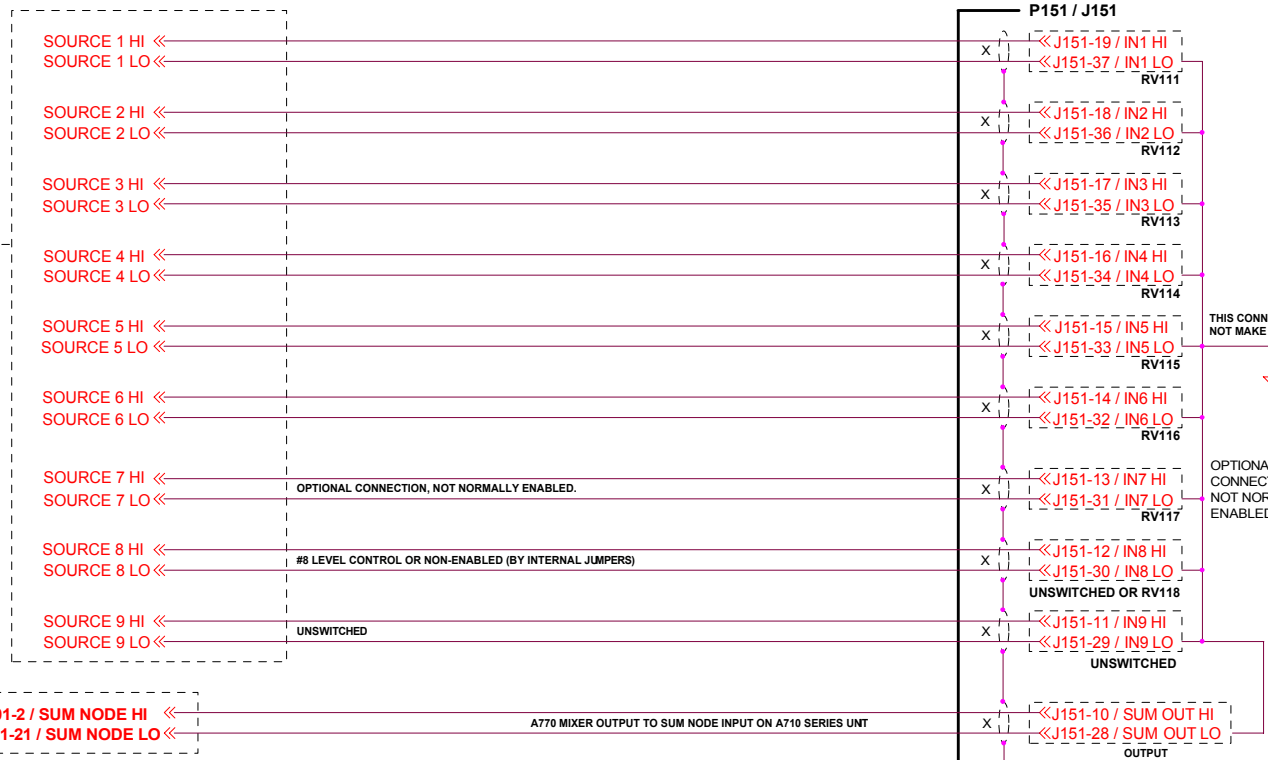

THIS CONNECTION SHOWN FOR REFERENCE ONLY, DO NOT MAKE IN HARNESS!  
 = FLOATING GROUND, NOT TIED TO LOCAL POWER SUPPLY COMMON.

OPTIONAL CONNECTION, NOT NORMALLY ENABLED.

**IMPORTANT !**  
 THE #8 POT POSITION CAN CONTAIN A VARIABLE INPUT, A SPEAKER LEVEL CONTROL, A MASTER ON/OFF SWITCH (INTERRUPTS COMPOSITE OUTPUT), AN ICS TIE SWITCH, OR AN ICS CALL SWITCH OR LIGHT. NOT ALL VARIABLE POSITIONS MUST BE FILLED, AND THIS UNIT MAY BE CUSTOMIZED IN MANY DIFFERENT WAYS TO SUIT A SPECIFIC INSTALLATION. IT IS PREFERRED TO MAKE SYSTEM CHANGES IN EYEBROW PANELS RATHER THAN CONTROL STATIONS LIKE THE A710/711, TO RETAIN HARNESS COMPATIBILITY.

DEFAULT "LOW SETTING" (FULL CCW) IS ELECTRICAL ZERO, BUT PROVISION IS MADE IN THE A775 FOR A 5% VOLUME SETTING AS AN OPTION ON ANY OR ALL INPUTS.

LOCAL CONTROL THAT REQUIRES THE EXPANDED INPUT SELECTIONS. (MAY BE CONNECTED TO ONLY ONE CONTROL !)

NORMALLY NO CONNECTION  
 NORMALLY NO CONNECTION

DIMMER BUS SELECT LIGHTING PIN

OPTIONAL CONNECTION, ONLY FOR A710/711 CONTROLS WITH REMOTE SPEAKER VOLUME CONNECTION ADDED TO RESERVED PIN. INTERNAL JUMPERS IN A770 MUST BE SET TO CONTROL THIS FUNCTION, AND PROPER POT (10K) MUST BE INSTALLED.

THESE FUNCTIONS NOT NORMALLY PRESENT, BUT CAN BE IMPLEMENTED AS OPTIONS IN A CUSTOM UNIT.

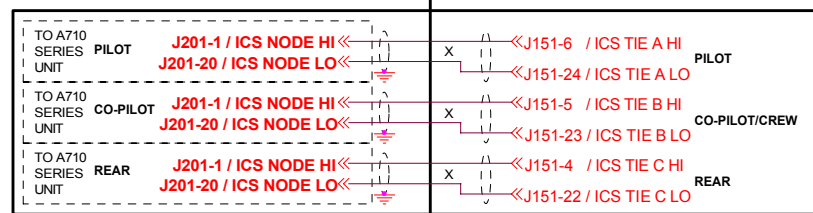

**WIRE DEFINITIONS:**

	SHIELDED WIRE, 24GA OR LARGER
	SHIELDED, LARGER
	SHIELDED, TWISTED PAIR, 24GA OR BIGGER
	SIGNAL WIRE, 22GA OR LARGER

HIGHEST DESIGNATION(S) USED

<b>TECHNISONIC</b> ALL DIMENSIONS ARE IN INCHES UNLESS SPECIFIED OTHERWISE STATED #1 → 0.1 #2 → 0.01 #3 → 0.001 ANGLES → 0° HOLE DIA → #003		Date: 7/July97 Drawn: Walter Shawlee 2/SRC Date: Approved:	<b>TIL</b> Technisonic Industries Ltd. 250 Watline Ave. Mississauga, Ontario L4Z 1P4 <b>TITLE: A775 Eyebrow Panel Interconnect A770Inst</b> Size: C Change Code: 38546 DWG#: 975295 REV: B Scale: Print Friday, July 11, 1997 Page: 1 of 1
---	--	---	--

## 2.5 INSTALLATION KIT - CONTENTS

The **IN-A770** installation kit (used for both **A770** & **A775** units) consists of:

1. One **37 pin female** D-subminiature mating connector complete with crimp pins, V-locks and hood. (DC37S) **P201**  
**Positronics p/n SD37F00JVLX +**  
**36ea. FC7520D contacts**  
**1ea. MC7520D contacts (goes in keyed position)**

Note: The mating connectors use a “one-hand”, tool-free Positronics V-lock assembly for ease of airframe installation and removal.

In addition, the following items **are packed with each A770/775 unit**:

1. This manual.
2. Warranty registration card.

**2.6 INSTALLATION - PIN LOCATIONS AND CONNECTIONS:**

- To improve understanding of the individual pin connections, a chart is provided that maps the functions of each pin in the connector, and shows the related and connected pins.
- Remember that in this system, audio lines are **FULLY FLOATING**, which means they do **NOT** use the airframe ground for their low return line. Even if the originating signal is grounded, it is imperative that **BOTH** the hi and lo lines be connected in every case.
- The audio lines not only float above ground, they float from each other, and ICS and radio lines common are **NOT** connected together. This further galvanic isolation prevents unwanted signal contamination, and greatly improves over-all system cross-talk performance in a completed installation.

**IMPORTANT**

- Charts are provided for both the **A770** and **A775** panels, and you will note that these units have essential harness compatibility, and that the **A775** is a SUB-SET of the **A770** wiring.
- **Connector Keying pins prevent accidental mis-installation in the airframe, but the matching lock-out pins MUST be installed into the mating connector to achieve this protection This is achieved by installing a male contact into the keying location, as it effectively blocks the connector from mating.**

**2.6.1 INSTALLATION - PIN LOCATIONS AND CONNECTIONS: A770 Eyebrow Panel**

The pin numbers and locations for the connectors located on the rear of the **A770 ACCESS/A** Eyebrow Panel are shown in the following table.

**Top Connector J161 DC37P  
(A770)**

**Mating Cable Connector: DC37S  
(37 Pin Female)**

J161		Connector Pin Assignments	Main Connector
Low	High	Connection	Notes
20	1	+28VDC Power Input	Main unit <b>Power/Ground</b> Ground (20) is also dimmer common
20	2	+5VDC Dimmer Input	Alternate dimmer connection
20	21	+28VDC Dimmer Input	Normal dimmer connection
	3	ICS ISO Light Output	Goes to <b>+28V</b> for internally selected station when ICS is <b>connected</b>
22	4	ICS TIE C	Normally for REAR station
23	5	ICS TIE B	Normally for CREW (co-pilot) station
24	6	ICS TIE A	Normally for PILOT station
25	7	Speaker Control	<b>Optional lines</b> (to attach to A710/11 station) Low side goes to local ground at A710/11
26	8	PATIENT/PAX H/S Switch	Right-hand-most RX switch-SW104 (#4) Optional connection, can be used to interrupt H/S audio, links/opens pins 8 and 26
27		Locating Pin	<b>(male pin for connector keying)</b>
	9	ICS CALL Line	Goes Low (ground) to signal an ICS Call Operation
28	10	SUM NODE OUT	To <b>Sum Node</b> on A7XX Audio Control Station (composite audio out)
29	11	INPUT #9	Unswitched input
30	12	INPUT #8	Unswitched input
31	13	INPUT #7	Unswitched input
32	14	INPUT #6	Right-hand-most RX switch-SW104 (#4)
33	15	INPUT #5	RX switch-SW103 (#3)
34	16	INPUT #4	RX switch-SW102 (#2)
35	17	INPUT #3	RX switch-SW102 (#2)
36	18	INPUT #2	Left-hand-most RX switch-SW101 (#1)
37	19	INPUT #1	Left-hand-most RX switch-SW101 (#1)

Common Lines	Floating above airframe ground in ACCESS systems, but serves as common signal low for corresponding input signal lines.
Common Lines	Floating above airframe ground in ACCESS systems, used only for <b>ICS node returns</b> in the system.

**View from solder side of DC37S MATING CONNECTOR:**

1.....19  
20.....37

**2.6.2 INSTALLATION - PIN LOCATIONS AND CONNECTIONS: A775 Eyebrow Panel**

The pin numbers and locations for the connectors located on the rear of the **A775 ACCESS/A** Eyebrow Panel are shown in the following table.

Top Connector J151 DC37P  
**(A775)**

**Mating Cable Connector: DC37S**  
(37 Pin Female)

J151		Connector Pin Assignments	Main Connector
Low	High	Connection	Notes
	1	Not used (reserved for power)	
<b>20</b>	<b>2</b>	+5VDC Dimmer Input	Alternate dimmer connection
<b>20</b>	<b>21</b>	+28VDC Dimmer Input	Normal dimmer connection
	3	Locating Pin	<b>(male pin for connector keying)</b>
<b>22</b>	4	Not used (reserved ICS TIE C)	Normally for REAR station
<b>23</b>	5	Not used (reserved ICS TIE B)	Normally for CREW (co-pilot) station
<b>24</b>	6	Not used (reserved ICS TIE A)	Normally for PILOT station
<b>25</b>	7	Speaker Control	<b>Optional lines</b> (to attach to A710/11 station) Low side goes to local ground at A710/11
<b>26</b>	8	Not used (reserved)	
<b>27</b>		Not used (reserved)	Ground
	9	Not used (reserved for ICS CALL Line)	Goes Low (ground) to signal an ICS Call Operation
<b>28</b>	10	SUM NODE OUT	To <b>Sum Node</b> on A7XX Audio Control Station (composite audio out)
<b>29</b>	11	INPUT #9	Unswitched input
<b>30</b>	12	INPUT #8	Right-hand-most <b>Optional</b> 8 <sup>th</sup> Control RV118
<b>31</b>	13	INPUT #7	<b>Optional</b> Control RV117 #7
<b>32</b>	14	INPUT #6	Control RV116 #6
<b>33</b>	15	INPUT #5	Control RV115 #5
<b>34</b>	16	INPUT #4	Control RV114 #4
<b>35</b>	17	INPUT #3	Control RV113 #3
<b>36</b>	18	INPUT #2	Control RV112 #2
<b>37</b>	19	INPUT #1	Left-hand-most Control RV111 #1

Common Lines	Floating above airframe ground in ACCESS systems, but serves as common signal low for corresponding input signal lines.
Common Lines	Floating above airframe ground in ACCESS systems, used only for <b>ICS node returns</b> in the system.

**View from solder side of DC37S MATING CONNECTOR:**

1.....19  
20.....37

**2.7**  **SIGNAL SOURCES**

The **A770 & A775 ACCESS/A** Audio Control Eyebrow Panels are intended for use with industry standard radio sources, with 50-100mW levels into 150/600 ohms. Levels should be approximately 4.5Vrms into these inputs, to achieve full power out from connected **A710/A711** stations. Note that all lines are FULLY FLOATING, and both hi and lo lines **must be connected in all cases**.

In all cases, the lines should be run as **shielded, twisted pairs**, to avoid contamination (and resulting cross-talk) of companion low level mic lines or audio input lines. Failure to follow this wiring guideline will result in unwanted cross-talk, and phantom audio that will appear to be transmit or intercom related.

**2.8**  **ICS ISO LIGHT/ICS CALL INSTALLATION**

The A770 can support a **remote ICS ISO indication function**.

The A770 can select any of 1 of 3 remote stations to associate with this output. The station that has the +28V output line mapped to it's respective switch is **internally programmable inside the A770 with jumper blocks**. This output is **asserted when a station is CONNECTED to the ICS network**. A typical way this may be implemented is with a remote GREEN light, labelled ICS CONNECTED. When the switch on the A770 is isolated (splitting the rear or other station from the common ICS bus), the light **will go out**. The +28V line can also be used with a relay to generate an inverted signal (with another +28V connection), to give an ICS DISCONNECTED light, if desired.

In addition, an ICS CALL line is supported in the **A770**. An internal switch sends a ground to other stations when pressed, to activate a remote ICS CALL light. If all these ICS functions are combined in a single remote external switch/pushbutton assembly, it can then be used for ICS CALLING (switch), to display ICS CONNECTED (green light) , and a second segment can be YELLOW, and labelled ICS CALL, to be activated by an incoming call signal. This yellow segment will light when an ICS call action is performed at any station in the system (the line is grounded by any switch). The **ICS call line** may also be connected to the **#6 voice alert** (ICS call audio alert) in systems equipped with this function.

**2.9**  **SPEAKER LEVEL CONNECTIONS**

The **A770** or **A775** can have a **Speaker Level Control** installed (in the far right hand position) to support speaker operation in an **A710** or **A711** station. This is an **optional function**, and is not required in headset based systems.

**2.10** **MAIN POWER +28VDC**

The main power +28VDC ( $\pm 20\%$ ) is connected to pin **1** of the 37 pin "D" connector (P/J161) on the **A770**. Power is not required in a standard **A775**.

As previously indicated, this connection should be made with at least **#22 AWG** wire, with **#20 AWG preferred**. If from a very noisy source, with high levels of parasitic AC, shielding may improve rejection of this coupled AC into other low level audio lines.

**2.11  BACKLIGHTING POWER +28VDC / +5VDC**

The backlighting power for the front panel of the **A770 and A775** is supplied via pins **21 or 2** of P/J151 or P/J161. Unless ordered and indicated otherwise on the rear of the **ACCESS/A A770 or A775**, the unit is shipped with the +28VDC backlighting option (pin **21**). Note that different pins are used for 5V and 28V lighting, and there is common lighting ground pin (pin **20**), which **MUST** be connected for the lighting to work.

**2.12 GROUND**

The **A770 and A775** eyebrow panels are designed for full audio signal Ground Isolation from the Airframe. This is necessary in many cases where the Airframe Ground causes significant noise in the Audio system.

Main ground (power return) to the **A770 and A775** is on pin **20** of the 37 pin "D" connector. All other groups of audio lines have their own "common" lines, which float above the airframe ground, to provide signal isolation. These common lines **MUST** be connected to the source audio, or no signal flow will result, except for stray leakage.

**2.13 STORAGE**

When not in use, Store the **A770 and A775** in the original bag and padded box if possible, and in a non-Humid place. Optimum storage temperatures for best shelf life should not exceed +35°C, or be less than -10°C.



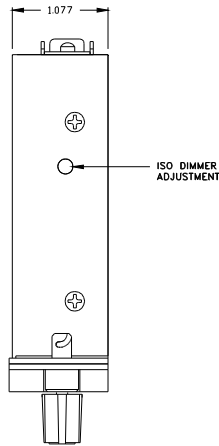

Side view of A770, showing ISO dimmer adjustment

**2.14 POST-INSTALLATION ADJUSTMENT LOCATIONS**

The **A770** has a single adjustment, which is to set the ISO LIGHT dimmer circuit.

**2.15 POST-INSTALLATION ADJUSTMENTS**

After installation, the **A770** may require adjustment of the ISO LIGHT dimmer circuit. This is the only installation adjustment. This adjustment is shown in section 2.14.

The unit adjustments are as follows:

Adjustment Name	Location	Procedure/purpose	Notes
ISO Light Dimmer	Side	Turn on panel dimmer circuit. ISO lamp on front panel of A770 will dim automatically. Set to suitable level for night flying, with no interference with pilots' vision.	<input checked="" type="checkbox"/> Can be set to mid position as default. Single turn adjustment.

**Unit modifications that can be set in the field during installation:**

**A770** Internal, removable jumpers may be set for the following items (**DEFAULT is BOLD**):

---

**Main RX Board**

<b>ISO LIGHT</b>	PILOT, CREW, <b>REAR</b>
<b>#6 INPUT</b>	<b>ENABLED</b> , DISABLED
<b>#8 POT ASSIGNMENT</b>	Set during manufacturing, not field settings.

**A775** Internal, removable jumpers may be set for the following items (**DEFAULT is BOLD**):

---

**Main RX Board**

<b>#8 POT ASSIGNMENT</b>	Set during manufacturing, not field settings.
--------------------------	---

## SECTION 3

### OPERATING INSTRUCTIONS

#### 3.1 FRONT PANEL OPERATORS SWITCHES AND CONTROLS

This section explains the operation of the **A770 & A775 ACCESS/A** Audio Control Eyebrow Panels, and how to use either unit in a typical aircraft environment with other ACCESS/A components. All normal user controls are on the front panel of the unit and are either variable rotating controls, or selectable pushbutton switches.

The exact radio/signal source legends on the face of the **A770** may vary from the illustrations shown, due to customer specifications, and the final legend insert that is installed for the specific aircraft installation. Full views of the common **A770** control panels are given in **Figure 3-1**.

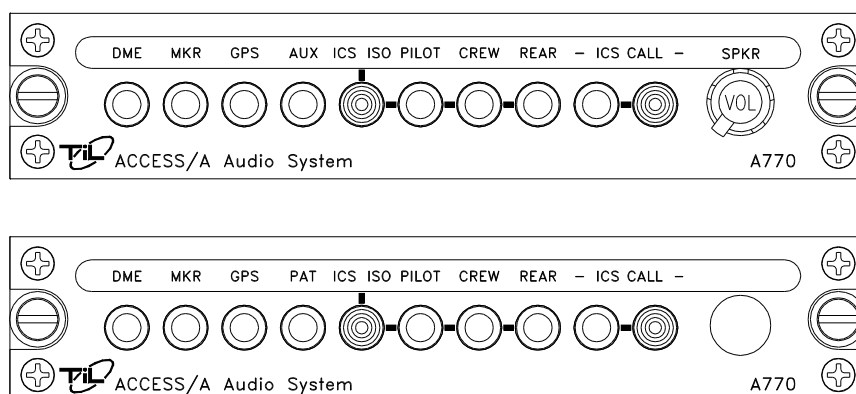
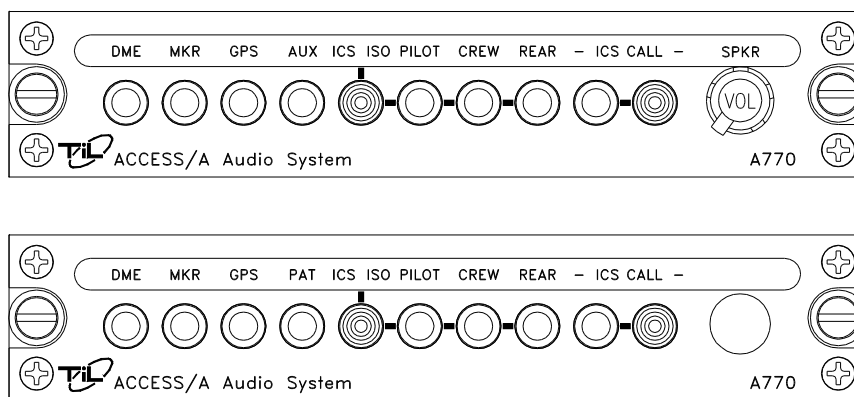

**FIGURE 3-1 A770 FRONT PANEL OPERATOR'S SWITCHES AND CONTROLS**

- **A770:** The left-hand row of round push-buttons (normally gray) selects the **RX** or **RECEIVER** audio to be sent to the companion A710/A711 station, and then to the crew headsets.
- **A770:** The next location (moving to the right) is the **ICS ISO LIGHT**, that shows the status of the ship's intercom audio (split or connected).
- **A770:** The next three round pushbuttons (normally white) select individual **ICS** connections, pushed in is **ON** or tied, out is **OFF** or split. .These switches are referred to as the **ICS ISO SWITCHES**. Any combination of ICS audio may be selected at one time, for system monitoring purposes.

- **A770:** The next switch (normally white/yellow or black) is the **ICS CALL SWITCH** (momentary pushbutton). This is used to send an ICS call command to a distant station, indicating you wish to re-establish ICS communication. The next indicator (to the right of the **ICS CALL SWITCH**), is the **ICS CALL LIGHT**, which lights whenever a remote station sends an ICS call command to this station, or when the local switch is pressed. If the companion A710/A711 control station is equipped with Voice Alerting, an internal alert can be triggered by this command signal, which will announce "intercom call" when the call switch is pressed.
- **A770:** The optional knob on the far right hand side of the panel is for the **SPEAKER LEVEL CONTROL**, if installed. This control can be used to adjust the cabin speaker level of a companion A710/A711 station, when connected.
- **A770:** Numerous variations of this eyebrow panel are possible, to accommodate special installation situations, and controls may be added or removed to suit.

The exact radio/signal source legends on the face of the **A775** may vary from the illustrations shown, due to customer specifications, and the final legend insert that is installed for the specific aircraft installation. Full views of the common **A775** controls are given in **Figure 3-2**.



**FIGURE 3-2 A775 FRONT PANEL OPERATOR'S SWITCHES AND CONTROLS**

- **A775:** The row of knobs starting at the left-hand side of the unit are **RADIO** or **RX LEVEL CONTROLS**, and can be used to individually set the desired level of any source (from essentially zero to full volume).
- **A775:** The far right hand side **MASTER SELECT SWITCH** (toggle) is used to select/de-select all signals individually set by the **LEVEL CONTROLS**.
- **A775:** The optional knob on the far right hand side of the panel is for the **SPEAKER LEVEL CONTROL**, if installed. This control can be used to adjust the cabin speaker level of a companion A710/A711 station, when connected.
- **A775:** Numerous variations of this eyebrow panel are possible, to accommodate special installation situations, and controls may be added or removed to suit.

3.1.1 RADIO RX SELECTION / LEVEL CONTROLS

This variable adjustment or pushbutton switch selects a specific audio source or pair of sources (**A770** only), and when a variable control, can also adjust the level independently from other signal sources, to achieve the exact balance required. On the **A770**, selection of these sources is by pushbutton switches (in for ON, out for OFF), and on the **A775**, there is a **MASTER SELECT**, or ON/OFF toggle switch that controls all signals at once. In addition, the **A775** also has individual level controls for each input (except the direct or unswitched input), to permit setting any desired balance. Note that the companion **A710/A711** station has ultimate control of the resulting composite RX audio selected by either eyebrow panel, and it will be set by the station's **RX LEVEL CONTROL**.

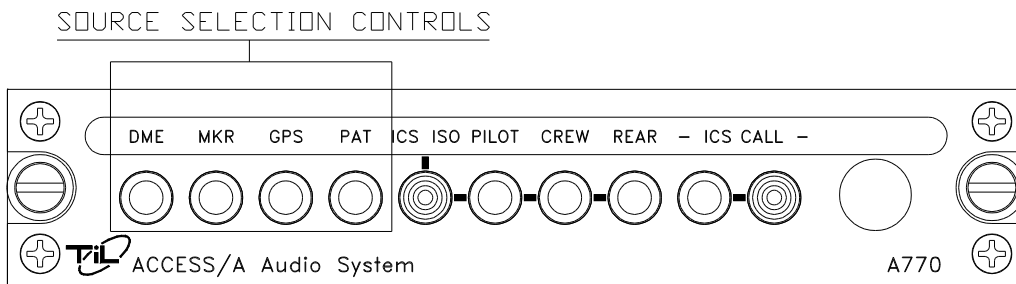

FIGURE 3-3 A770 SELECTION CONTROLS

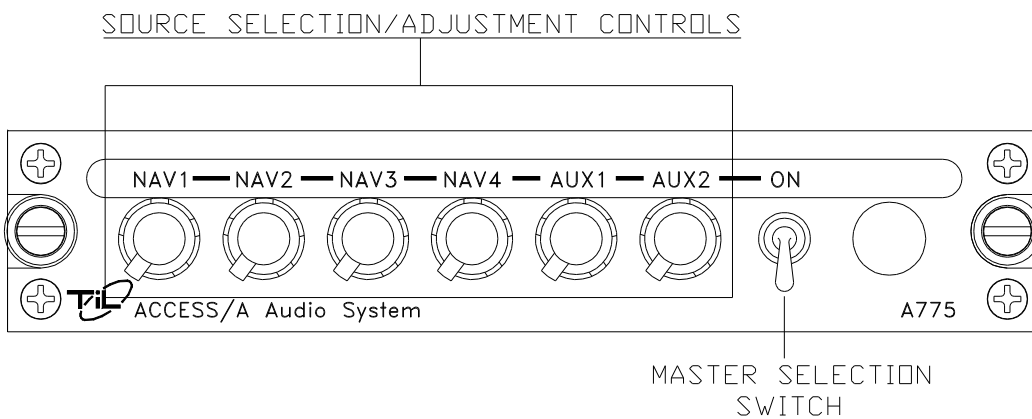
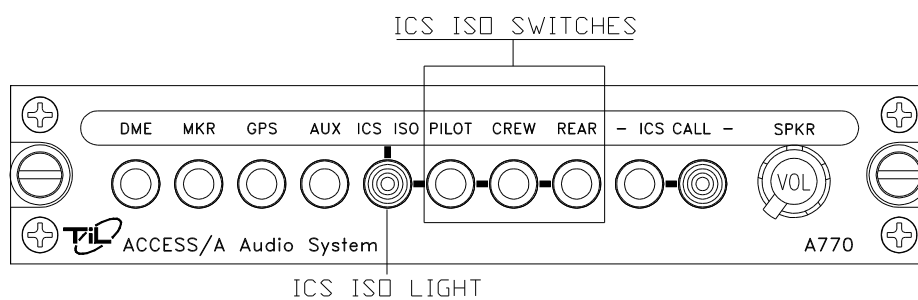

FIGURE 3-4 A775 SELECTION & ADJUSTMENT CONTROLS

**3.1.2 ICS or INTERCOM ISOLATION FUNCTIONS**

The **A770** has the ability to tie or split the ship's intercom system as needed during flight. There are three **ICS ISO SWITCHES** that control each key station (Pilot, Crew or co-pilot, and Rear), and they allow each station to be controlled independently. Pressing each switch **IN**, **attaches or ties it** to the ICS network, returning it **OUT**, **disconnects the station or splits it** from the network.

The **ICS ISO LIGHT** changes color, depending on the intercom status of the aircraft. If all stations are **connected**, then the light is **GREEN**. If **ANY** station is **isolated** (switch out), then the light turns **AMBER**, to caution that ship-wide communication is no longer possible. This light is auto-dimmed from the panel dimmer bus; if any panel dimmer voltage is present (night flying), then the lamp will drop to the pre-set dim setting, to avoid cockpit glare if in the pilot's field of vision.



**FIGURE 3-5 A770 ICS ISOLATION CONTROLS**

**3.1.3 ICS CALL FUNCTIONS**

The **A770** has both an **ICS CALL SWITCH** (momentary pushbutton), and an **ICS CALL LIGHT**. These are used to re-establish ICS communication once the connecting ICS tie lines are open, and voice communication is no longer possible. Pressing the switch lights local and distant call lights, and can also trigger voice alerting messages in the companion **A710/A711** control station to alert the user to re-establish communication. The **ICS CALL** function is asserted only as long as the button is depressed.

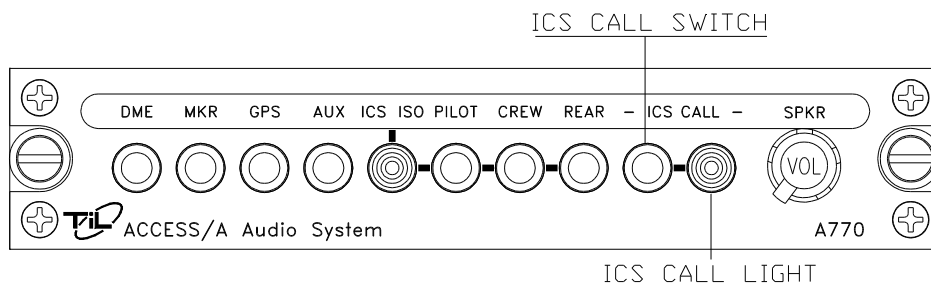

**FIGURE 3-6 A770 ICS CALL CONTROLS**

3.1.4 SPEAKER LEVEL CONTROL

The **A770** and **A775** can have an optional **SPEAKER LEVEL CONTROL** installed in the far right hand position of the panel. This works in conjunction with a companion **A710/A711** control station to give local control of the speaker audio output. The control can be preset internally to go to zero, or to 5% as the minimum level.

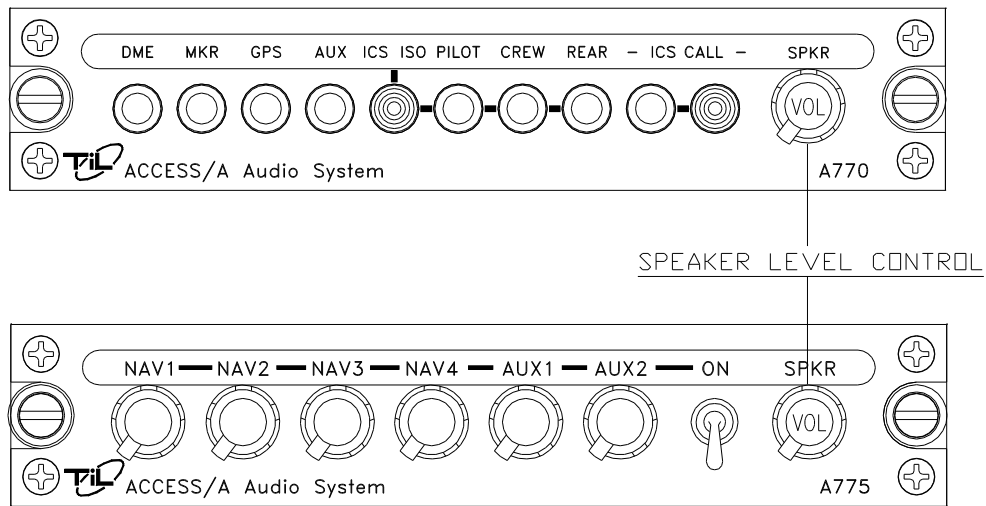

FIGURE 3-7 A770/A775 SPEAKER LEVEL CONTROLS

### 3.2 SPECIAL SIGNAL CONSIDERATIONS

There are several special signals and lines related the A770 and A775, which require careful installation planning, and understanding by the flight crew.

#### 3.2.1 DIRECT AUDIO CONNECTIONS

The **A770** and **A775** have *un-switched, direct audio inputs*. These allow a signal to be routed into the audio system without front panel control of the source. In the **A770**, these inputs (2) can be used as required, and are fed into the companion **A710/A711** station, where they are adjusted by the RX LEVEL CONTROL.

In the **A775**, the direct input has no front panel level control, but it IS controlled by the MASTER ON/OFF toggle switch.

#### 3.2.2 SUM NODE

This line is used to *expand the RX input bus* of the **A710/A711** control, and allows many supplemental receivers to be attached with high isolation from other signals. Use of either the **A770** or **A775** eyebrow expansion units is required to tie to this line. All radio sources monitored by the A770 or A775 are sent to the sum node inside a companion **A710/A711** unit. Only one station may be connected in this way, or severe cross-talk will result. Signals directed to this station input will be muted during TX operation, just as for any other RX input.



### 3.3 CHANGING OVERLAY LIGHTING & RADIO LEGENDS

The legends on the **A770** and **A775** front panels, and the overlay color and lighting type can all be easily changed in the field to suit special requirements. The entire lighted overlay is changed by removing four screws, as illustrated below. Remove the knobs (use a 0.050" Allen/Hex key to undo the set screws), and the overlay assembly will pull off. A small polarized square plug on a pendant cable mates with the main board, and can be pulled off to allow the overlay to be completely removed and exchanged. If the lighting **VOLTAGE** is changed, the **internal connection must also be changed**, as well as the overlay. See the service manual for details.

The legend insert is adhesive, and can be removed by lifting a corner free with a sharp X-acto knife blade, and then gently pulling the entire Lexan strip free. Remove the backing from a new legend strip (with the desired legends), line it up evenly, and press it into place on the overlay recess. The adhesive will cure fully in 48 hours. Be sure any bubbles are pressed out, and that all edges are firmly attached.

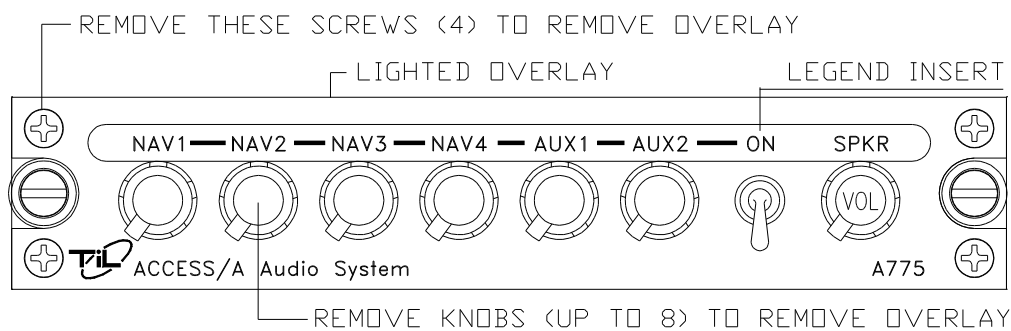

**FIGURE 3-8 OVERLAY & LEGEND INSERT**